

Verification & Validation: Overview, Requirement-based testing

Systems Engineering BSc Course

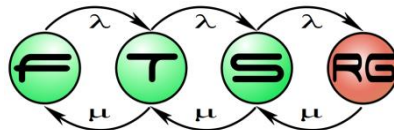

Platform-based systems design

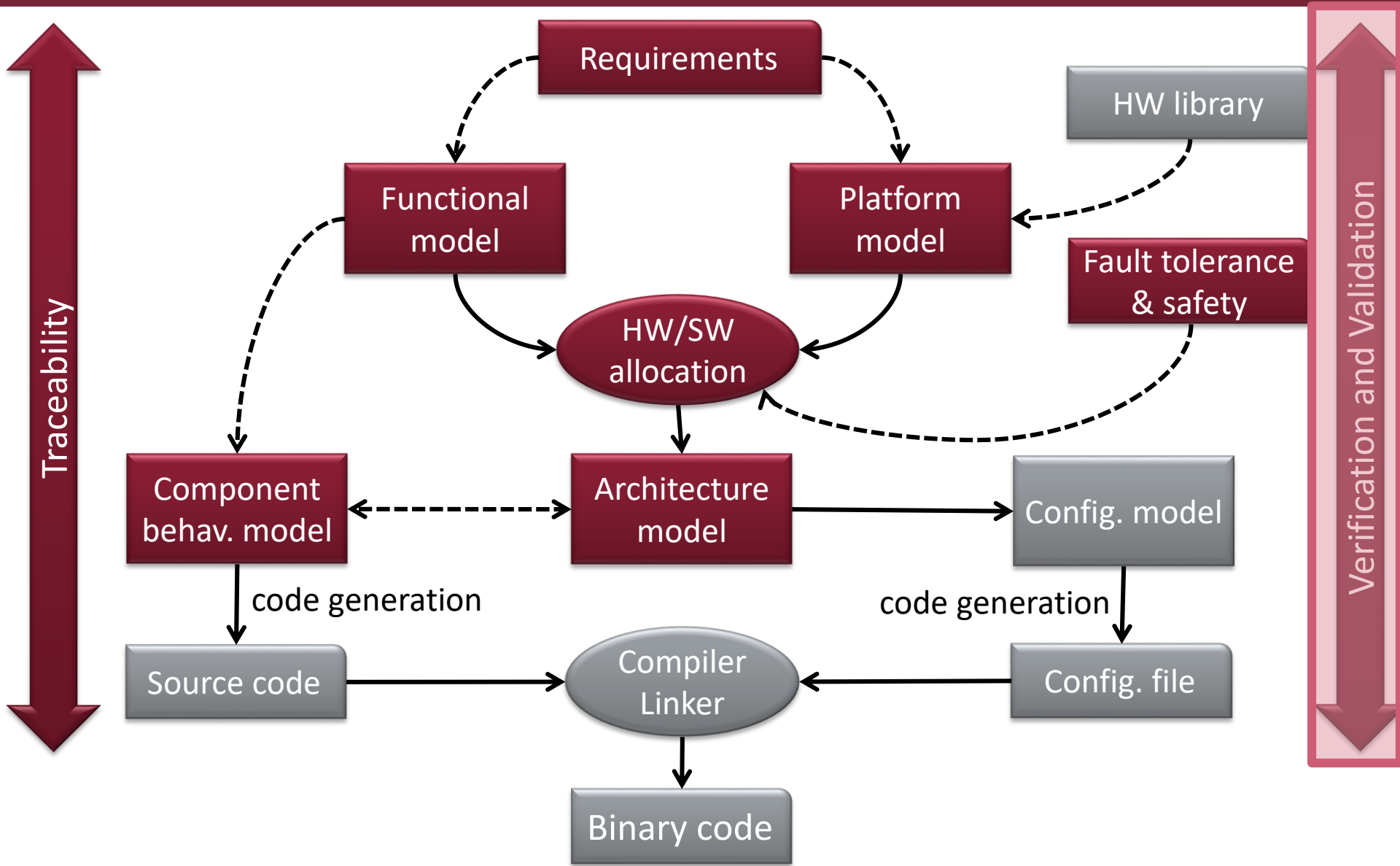

Learning Objectives

V&V overview

- List typical V&V activities
- Classify verification techniques according to their place in the lifecycle

Requirement-based testing

- Recall basic testing concepts
- Describe the goal of specification-based test design techniques
- Use basic test design techniques

Overview of V&V techniques

Typical steps in development lifecycle

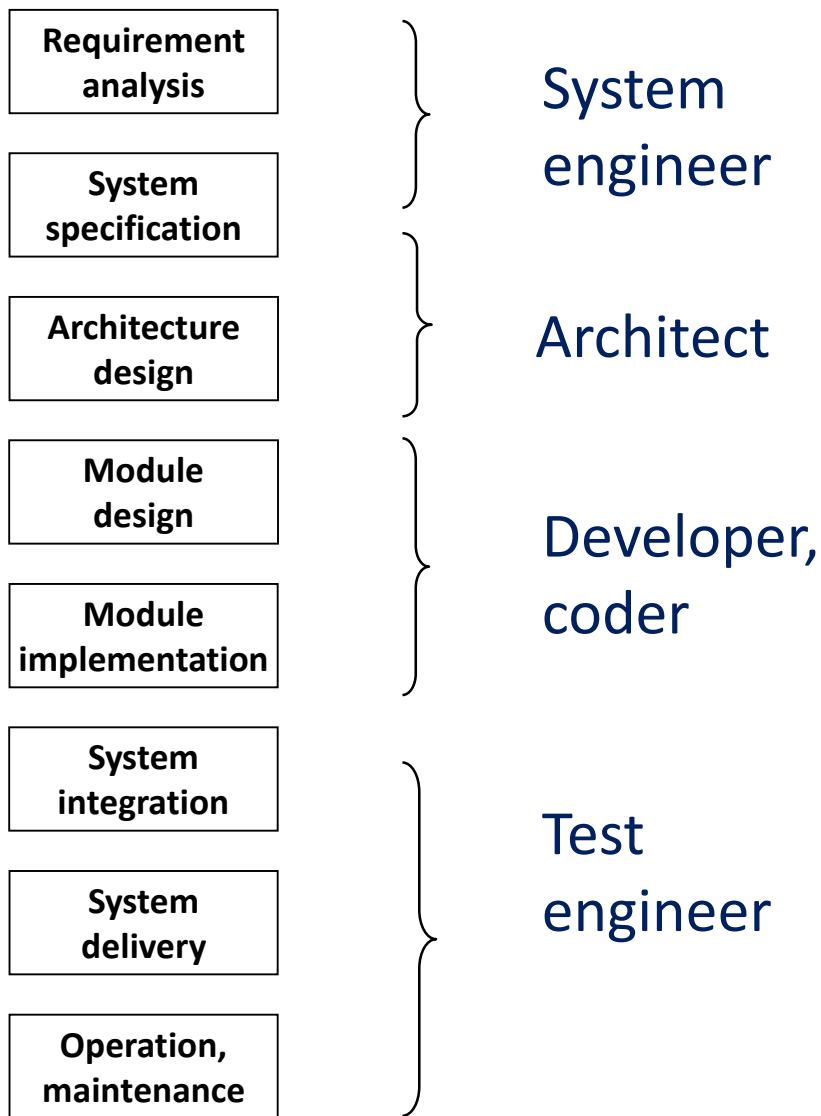

Schedule, sequencing depends on lifecycle model!

Requirement analysis

- Requirement analysis
- System specification
- Architecture design
- Module design
- Module implementation
- System integration
- System delivery
- Operation, maintenance

Task	V&V criteria	V&V technique
Defining functions, actors, use cases	<ul style="list-style-type: none"> - Risks - Criticality 	<ul style="list-style-type: none"> - Checklists - Failure mode and effects analysis

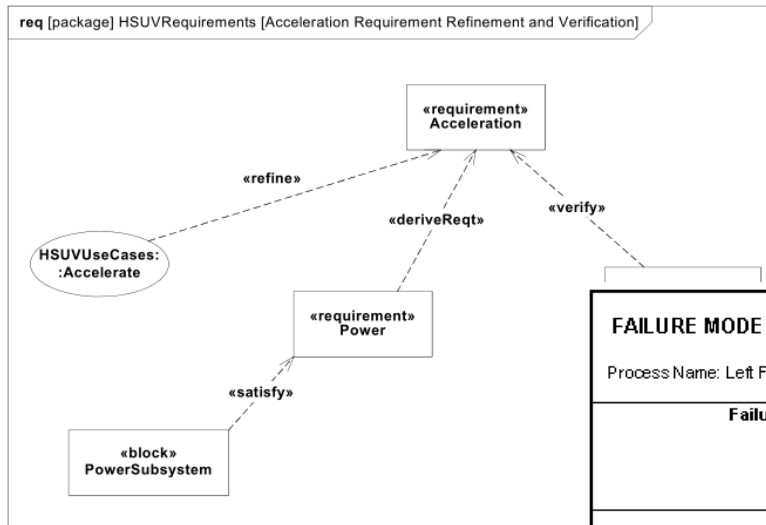

FAILURE MODE & EFFECTS ANALYSIS (FMEA)				Date: 1/1/2000
Process Name: Left Front Seat Belt Install		Process Number: SBT 445		Revision: 1.3
Failure Mode	A) Severity Rate 1-10 10 = Most Severe	B) Probability of Occurrence Rate 1-10 10 = Highest Probability	C) Probability of Detection Rate 1 - 10 10 = Lowest Probability	Risk Preference Number (RPN) AxBxC
1) Select Wrong Color Seat Belt	5	4	3	60
2) Seat Belt Bolt Not Fully Tightened	9	2	8	144
3) Trim Cover Clip Misaligned	2	3	4	24

System specification

Requirement analysis

System specification

Architecture design

Module design

Module implementation

System integration

System delivery

Operation, maintenance

Task	V&V criteria	V&V technique
Defining functional and non-functional requirements	<ul style="list-style-type: none"> - Completeness - Unambiguity - Verifiability - Feasibility 	<ul style="list-style-type: none"> - Reviews - Static analysis - Simulation

BookStore rendszer	Verzió: 2.2
Szövekvetelmény-specifikáció (SRS)	Dátum: 2010.10.22

A funkciók a következő főbb csoportokba sorolhatóak.

- Be- és kijelentkezés,
- Könyvek böngészése és vásárlása,
- Karbantartási munkák.

A funkciók részletes leírása a 3.2 fejezetben található.

1.5 Felhasználói jellemzők

A rendszer felhasználói a következő jól elkülönülő csoportokból állnak.

- **Ügyfelek:** a rendszert alapvetően nem ismerő, előképzettséggel nem rendelkező szer
- **Adminisztrátorok:** a rendszer üzemeltetői, akik részletes kiképzést kaptak a rendszer és működéséről.

1.6 Definíciók

A rendszer főbb fogalmai a következőképp definiálhatóak.

Ügyfél (Client)	A rendszer szolgáltatását igénybe vevő felhasználó, aki könyvet akar
Adminisztrátor (Administrator)	A rendszer karbantartását végző személy.
Könyv (Book)	Egy absztrakt elem, mely egy, a rendszerben forgalmazott k reprezentálja.
Példány (Instance)	Egy könyv konkrét, megvásárolható példánya.

List of desired requirement characteristics

- **Necessary:** If it is removed or deleted, a deficiency will exist, which cannot be fulfilled by other capabilities
- **Implementation Free:** Avoids placing unnecessary constraints on the design
- **Unambiguous:** It can be interpreted in only one way; is simple and easy to understand
- **Complete:** Needs no further amplification (measurable and sufficiently describes the capability)
- **Singular:** Includes only one requirement with no use of conjunctions
- **Feasible:** Technically achievable, fits within system constraints (cost, schedule, regulatory...)
- **Traceable:** Upwards traceable to the stakeholder statements; downwards traceable to other documents
- **Verifiable:** Has the means to prove that the system satisfies the specified requirement

Architecture design

Requirement analysis

System specification

Architecture design

Module design

Module implementation

System integration

System delivery

Operation, maintenance

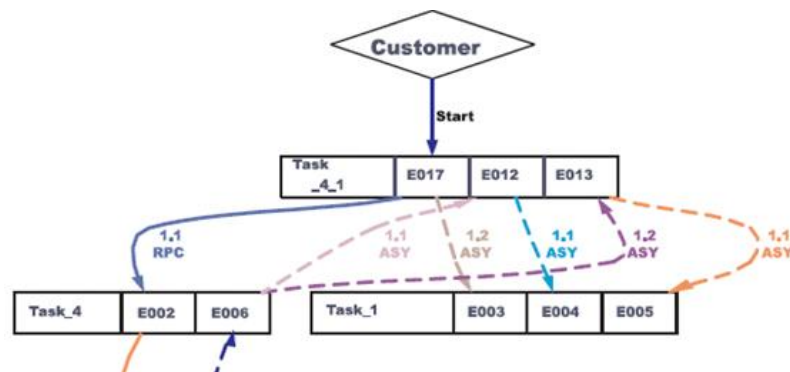
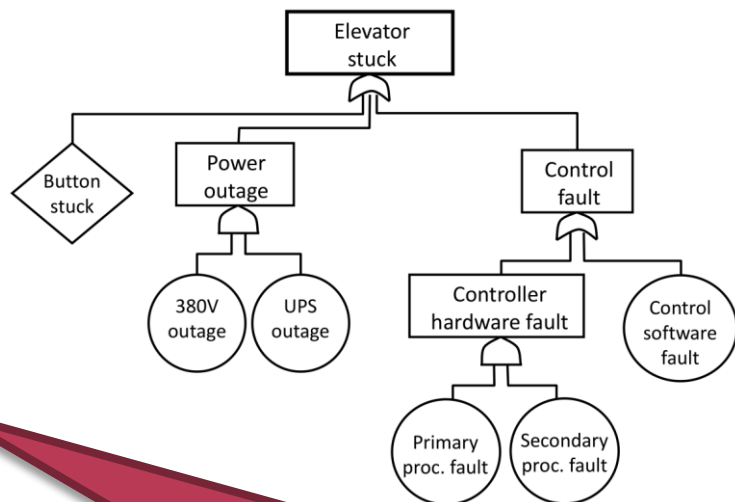

Task	V&V criteria	V&V technique
<ul style="list-style-type: none"> - Decomposing modules - HW-SW co-design - Designing communication 	<ul style="list-style-type: none"> - Function coverage - Conformance of interfaces - Non-functional properties 	<ul style="list-style-type: none"> - Static analysis - Simulation - Performance, dependability, security analysis

Module design (detailed design)

Requirement analysis

System specification

Architecture design

Module design

Module implementation

System integration

System delivery

Operation, maintenance

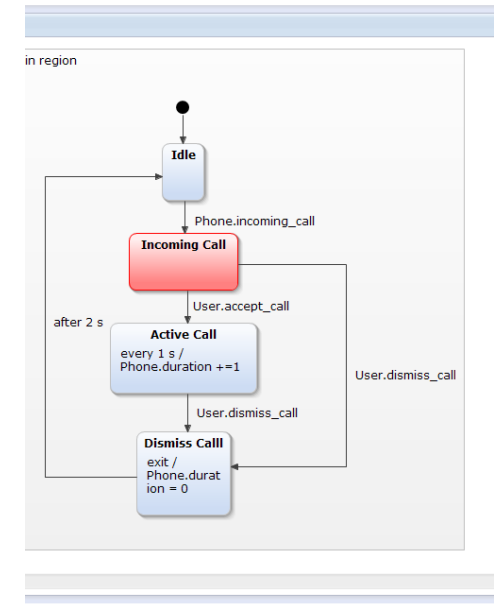
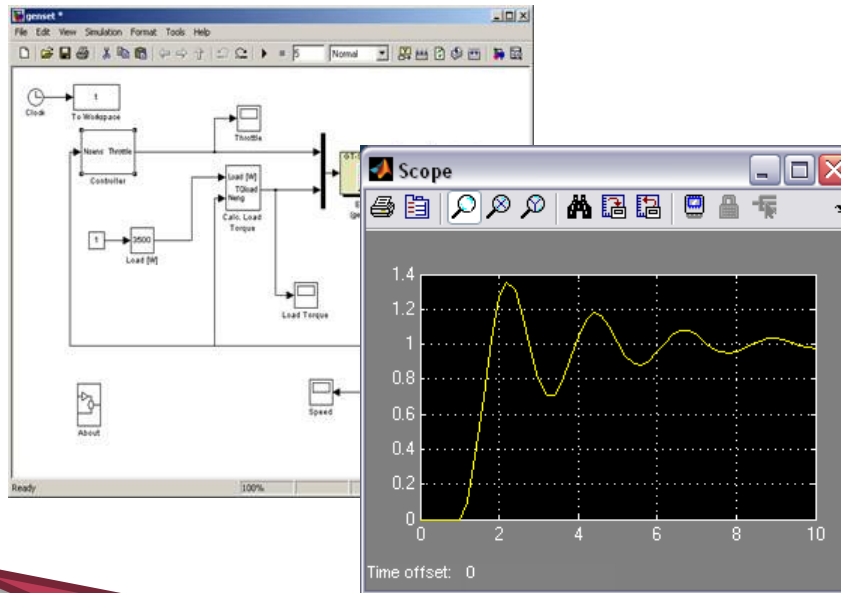

Task	V&V criteria	V&V technique
- Designing detailed behavior (data structures, algorithms)	- Correctness of critical internal algorithms and protocols	- Static analysis - Simulation - Formal verification - Rapid prototyping

Module implementation

Requirement analysis

System specification

Architecture design

Module design

Module implementation

System integration

System delivery

Operation, maintenance

The screenshot displays the SonarQube interface. On the left, a code snippet is shown with line numbers 110 to 122. A comment above the code asks 'Why do you move this out?' and 'Because it would be identical'. The code includes private methods like `patchSet`, `changeMessage`, `sshInfo`, `validatePolicy`, `draft`, `runHooks`, `sendMail`, `uploader`, and `batchRefUpdate`. A central panel shows a list of issues, with one issue selected: 'Bug' with a severity of 'Major', status 'Open', and resolution 'Fixed'. A table below shows the resolution status: Unresolved (118), False Positive (0), and Removed (41). On the right, a test suite summary shows 'All JUnit Tests [Runner: JUnit 3] (0.469 s)' with a list of individual tests and their durations, such as `junit.samples.VectorTest (0.000 s)` and `junit.samples.money.MoneyTest (0.000 s)`. The top right corner indicates 'Runs: 119/119', 'Errors: 0', and 'Failures: 0'.

Task	V&V criteria	V&V technique
- Software implementation	Code is - Safe - Verifiable - Maintainable	- Coding conventions - Code reviews - Static code analysis
- Verifying module implementation	- Conformance to module designs	- Unit testing - Regression testing

System integration

Requirement analysis

System specification

Architecture design

Module design

Module implementation

System integration

System delivery

Operation, maintenance

Task	V&V criteria	V&V technique
<ul style="list-style-type: none"> - Integrating modules - Integrating SW with HW 	<ul style="list-style-type: none"> - Conformance of integrated behavior - Verifying communication 	<ul style="list-style-type: none"> - Integration testing (incremental)

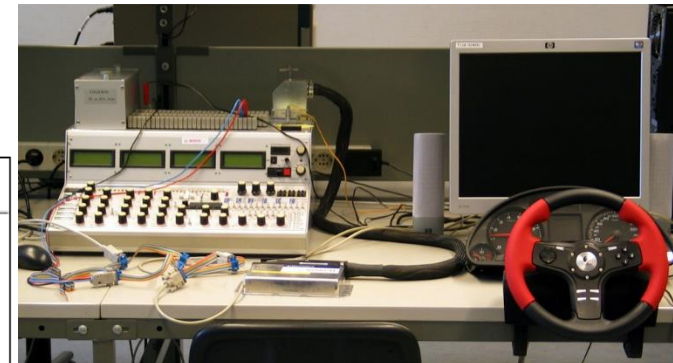
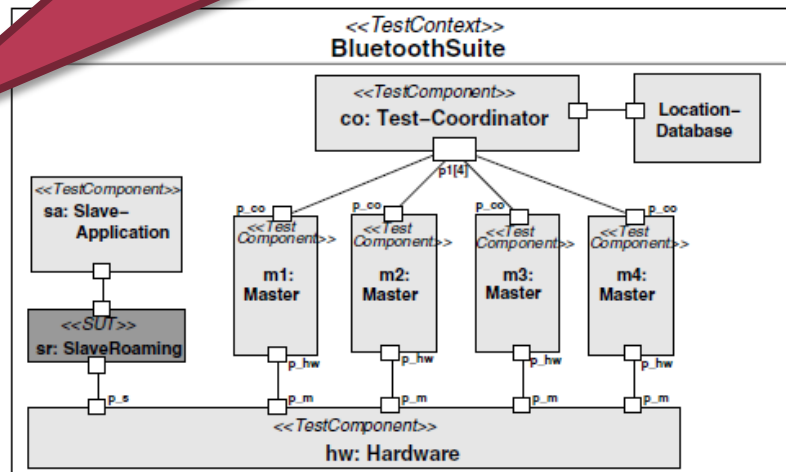

System delivery and deployment

Requirement analysis

System specification

Architecture design

Module design

Module implementation

System integration

System delivery

Operation, maintenance



Source: [Video and radar test](#) (Bosch)



Source: [Consumer Reports](#)

Task	V&V criteria	V&V technique
- Assembling complete system	- Conformance to system specification	- System testing - Measurements, monitoring
- Fulfilling user expectations	- Conformance to requirements and expectations	- Validation testing - Acceptance testing - Alfa/beta testing

Operation and maintenance

Requirement
analysis

System
specification

Architecture
design

Module
design

Module
implementation

System
integration

System
delivery

Operation,
maintenance

Tasks during operation and maintenance:

- Failure logging and analysis (for failure prediction)
- V&V of modifications

Mini-lifecycle
for each
modification

Basic V&V Concepts

Recap from *Software Engineering* course

V&V techniques

Static

- What: any artefact (documentation, model, code)
- How: without execution
- E.g.: review, static analysis

Dynamic

- What: executable artefacts (model, code...)
- How: with execution
- E.g.: simulation, testing

Basic concepts

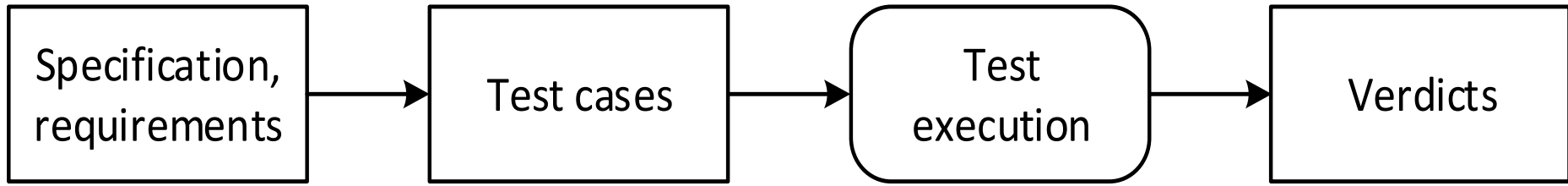

- **SUT:** system under test
- **Test case**
 - a set of test inputs, execution conditions, and expected results developed for a particular objective
- **Test suite**
- **Test oracle**
 - A principle or mechanism that helps you decide whether the program passed the test
- **Verdict:** result (pass / fail /error / inconclusive...)

Problems and tasks

- Test selection
 - What test inputs and test data to use?
- Oracle problem
 - How to get/create reliable oracle?
- Exit criteria
 - How long to test?
- Testability
 - Observability + controllability

V&V in the V-model

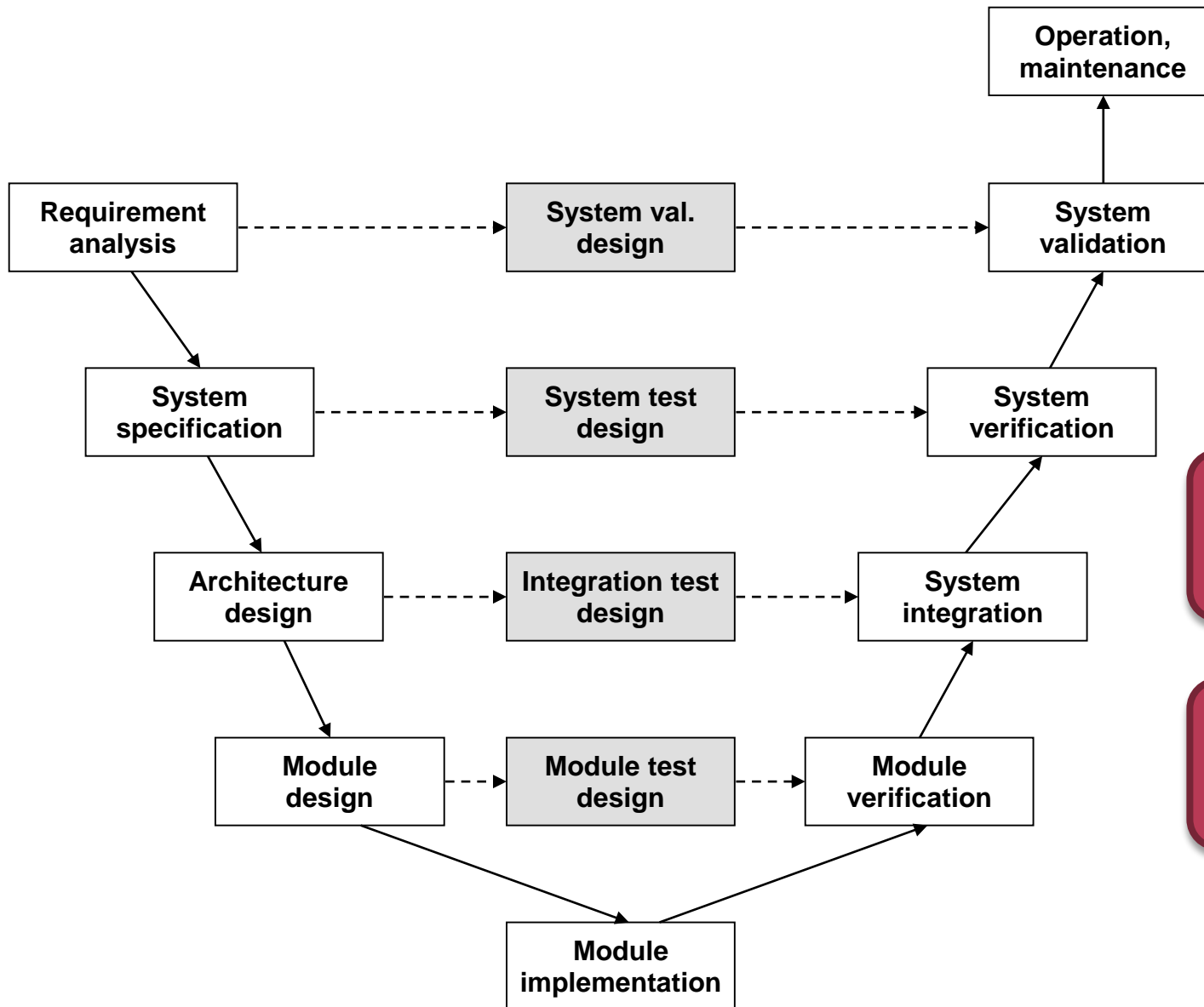

V&V in each step!

Not just after coding

Case study: AUTOSAR Acceptance Tests

Source: [AUTOSAR ATS Overview](#), [AUTOSAR ATS RTE](#)

AUTOSAR concepts (recap)

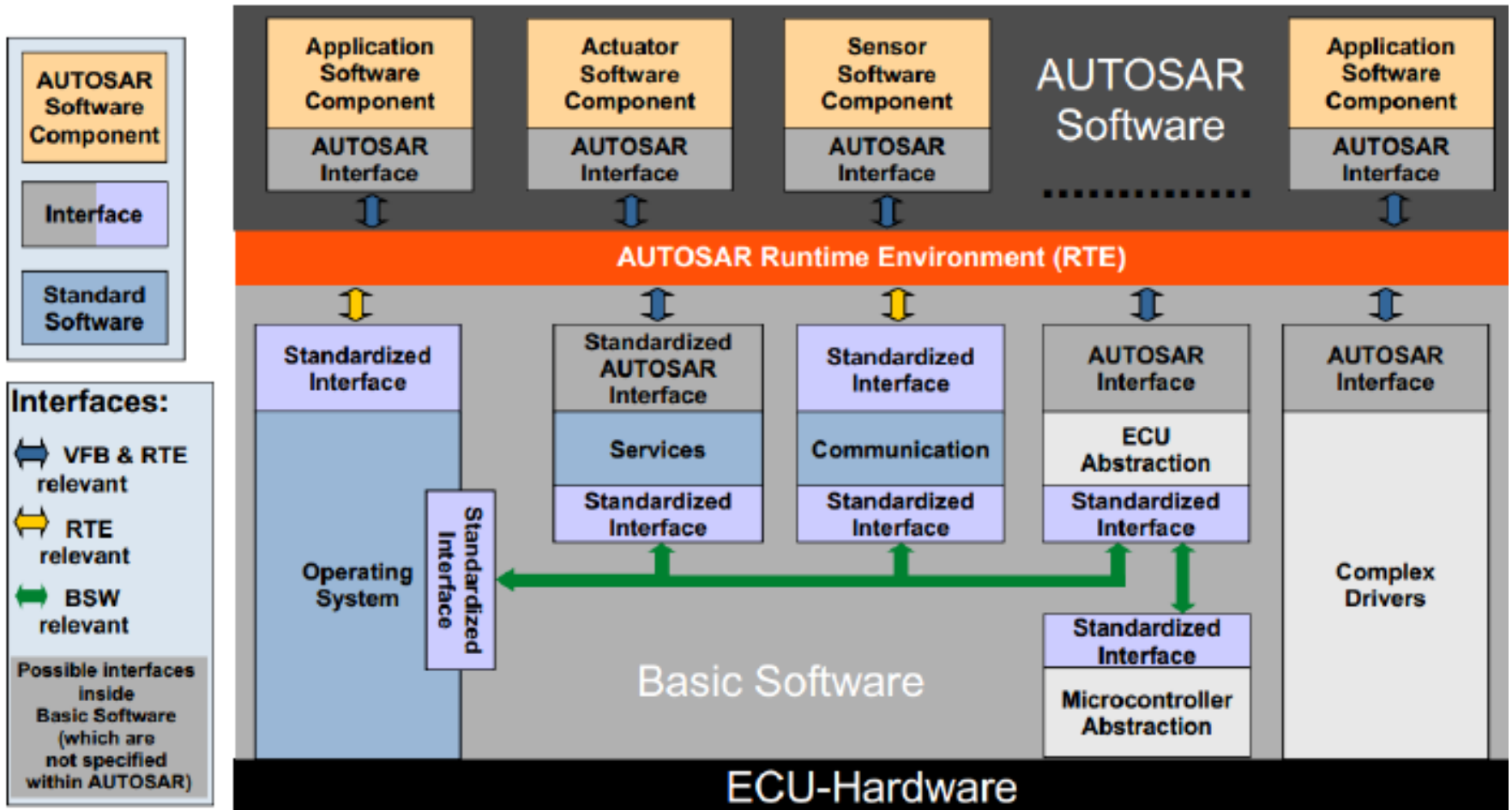

AUTOSAR Acceptance Tests

- System-level tests based on specification
- Checks visible functionalities
 - Application level and Bus level
- Acceptance Test Specifications (ATS)
- Test suites for different specifications
 - Communication (CAN, FlexRay...), Memory stack, **Runtime Environment [RTE]**...

Example: AUTOSAR ATS RTE

- Tests RTE functionality
- 5 features, 68 test cases, 251 pages (!)

Feature: RTE Client Server Communication

- *General Test Objectives:*
cover the Client Server
feature of the RTE
[RS_BRF_01312]

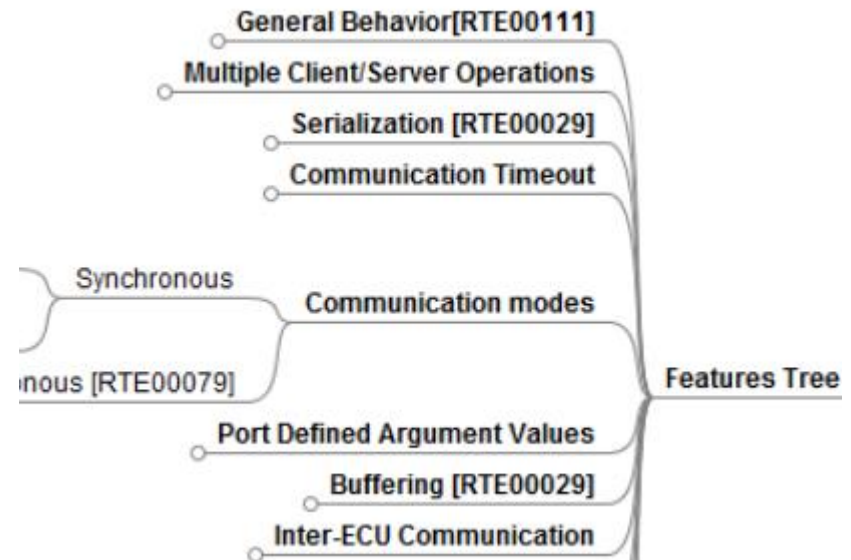

Requirements and specification to test

[RS_BRF_01312] *AUTOSAR RTE shall support calling of subroutines (client/server call, including remote procedure calls).*



Refine

[SRS_Rte_00029] *The RTE shall support multiple-client-single-server ("n:1") client-server (function invocation) communication.*

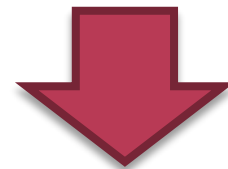

Refine

[SWS_Rte_04516] *The RTE's implementation of the client-server communication shall ensure that a service result is dispatched to the correct client if more than one client uses a service.*

How can we test this functionality?

What is needed to define a test

- Test architecture
 - SUT, simulated components, test drivers and stubs...
- Test configuration and data
 - Parameters, message data...
- Test cases
 - Test goal, pre-conditions, sequence of steps (input + expected output), post-conditions...

Test architecture

Starting and controlling tests

Software Components for testing

System Under Test

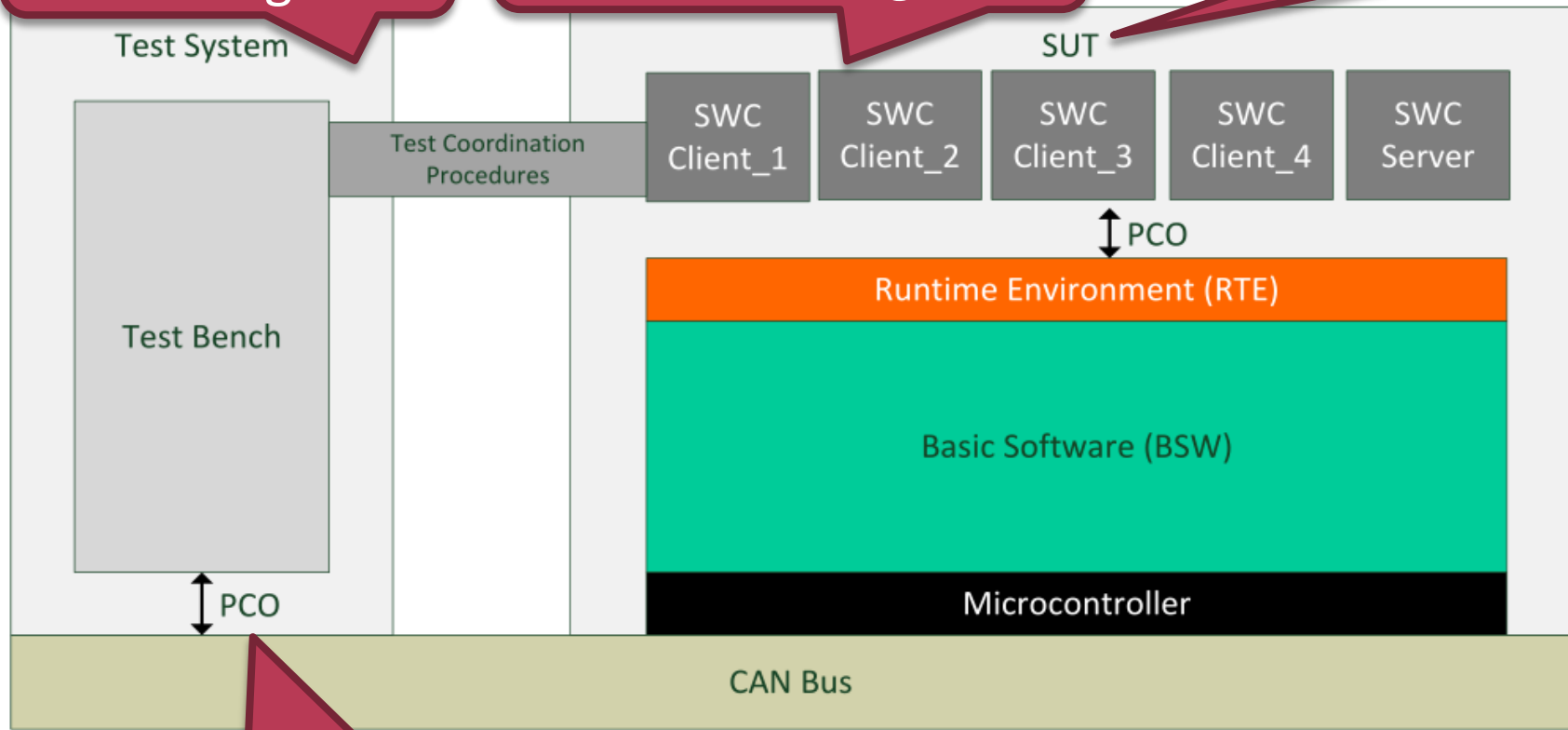

Point of Control and Observation

Test configuration (excerpt)

SWC Name	Tester_Server			
PORTS	Name	ServerA		
	Type	PPortPrototype		
	Interface	PrimitiveData_IF		
	Requirements			
RUNNABLE ENTITIES	Name	serverRead		
	Requirements	canBelInvokedConcurrently=false send back data from global variable written by serverWrite		
	Started by Event	Name	OIE_ReadA	
		Type	OperationInvokedEvent	

Test case

Test Objective	Test synchronous server call for n:1 intra-ECU Client-Server communication		
ID	ATS_RTE_00052	AUTOSAR Releases	3.2.1 3.2.2 4.0.3 4.1.1 4.2.1
Affected Modules	RTE	State	reviewed
Trace to SWS Item	RTE: SWS_Rte_02527 RTE: SWS_Rte_04515 RTE: SWS_Rte_04516 RTE: SWS_Rte_04519		
Configuration Parameters	<p>See UC01.01 in chapter 3.1.2 Test Configuration.</p> <p>This test case uses:</p> <p>Tester_Client_1</p> <ul style="list-style-type: none"> * port Client1A * runnable RUN_Client1 (sscp_Read1A, sscp_Write1A) <p>Tester_Client_3</p> <ul style="list-style-type: none"> * port Client3A * runnable RUN_Client3 (sscp_Write3A) <p>Tester_Server</p> <ul style="list-style-type: none"> * port ServerA * runnable serverRead * runnable serverWrite <p>Client1A and Client3A connected to ServerA.</p>		

Test case (cont'd)

Summary

The goal of this test is to check the behavior of synchronous server calls in case of n:1 Intra-ECU Client-Server communication.

2 clients connected to the same server are invoking (synchronous server call) successively the same operation of the server.

The Test Manager checks that the operations are handled correctly.

Pre-conditions

None

Test case (cont'd)

Main Test Execution		
Test Steps		Pass Criteria
Step 1	[CP] start RUN_Client1, RUN_Client3	
Step 2	[RUN<RUN_Client1>] execute Rte_Call_Client1A_Write(DataValue1)	[RUN<RUN_Client1>] Rte_Call returns RTE_E_OK
Step 3	[RUN<RUN_Client3>] execute Rte_Call_Client3A_Write(DataValue2)	[RUN<RUN_Client3>] Rte_Call returns RTE_E_OK
Step 4	[RUN<RUN_Client1>] execute Rte_Call_Client1A_Read	[RUN<RUN_Client1>] Rte_Call returns RTE_E_OK, data returned is DataValue2
Step 5	[CP] terminate RUN_Client1, RUN_Client3	
Post-conditions	None	

Specification-based test design

Test design techniques

Goal: Select test cases based on test objectives

Specification-based

- SUT: black box
- Only spec. is known
- Testing specified functionality

Structure-based

- SUT: white box
- Inner structure known
- Testing based on internal behavior

Specification-based techniques

Equivalence
classes

Boundary
values

Based on
use cases

Combinatorial
testing

Decision
tables

...

Equivalence class partitioning

- Input and output **equivalence classes**:
 - Data that are expected to **cover the same faults** (cover the same part of the program)
 - Goal: **Each** equivalence class is represented by one test input (selected test data)
- Highly **context-dependent**
 - Needs to know the domain and the SUT!
 - Depends on the skills and experience of the tester

Selecting equivalence classes

- Selection uses **heuristics**
 - Initial: **valid** and **invalid** partitions
 - Next: refine partitions
- Typical heuristics:
 - **Interval** (e.g. 1-1000)
 - < min, min-max, >max
 - **Set** (e.g. RED, GREEN, BLUE)
 - Valid elements, invalid element
 - **Specific format** (e.g. first character is @)
 - Condition true, condition false
 - **Custom** (e.g. February from the months)

Deriving test cases from equiv. classes

- Combining equiv. classes of several inputs
- For **valid** (normal) equivalence classes:
 - test data should cover as much equivalence classes as possible
- For **invalid** equivalence classes:
 - first covering the each invalid equivalence class separately
 - then combining them systematically

EXERCISE Equivalence partitions

Requirement: The loan application shall be denied if the requested amount is larger than 1M Ft and the customer is a student, unless the amount is less than 3M Ft and the customer has repaid a previous loan (of any kind).

- Input parameters? Equivalence classes?
- Any questions regarding the requirement?

Specification-based techniques

Equivalence
classes

Boundary
values

Based on
use cases

Combinatorial
testing

Decision
tables

...

2. Boundary value analysis

- Examining the **boundaries of data partitions**
 - Focusing on the boundaries of equivalence classes
 - Both **input** and **output** partitions
- **Typical faults** to be detected:
 - Faulty relational operators,
 - conditions in cycles,
 - size of data structures,
 - ...

Typical test data for boundaries

- A boundary requires 3 tests:

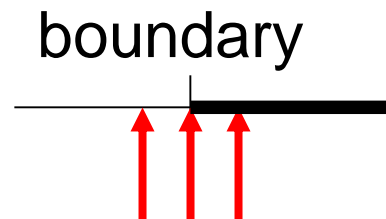

- An interval requires 5-7 tests:

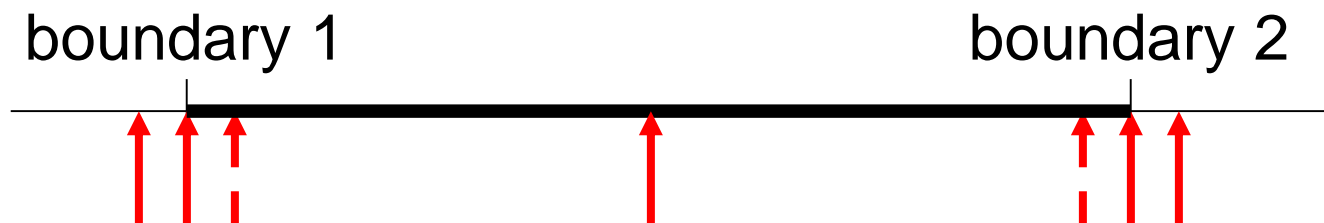

EXERCISE Boundary values

Requirement: If the robot detects that a human is closer than 4 meter, then it has to slow down, and if it is closer than 2 meter, then it has to stop.

- What values to use for testing?
- Any other questions regarding the requirement?

Specification-based techniques

Equivalence
classes

Boundary
values

Based on
use cases

Combinatorial
testing

Decision
tables

...

Deriving tests from use cases

- Typical test cases:
 - 1 test for **main path** („happy path“, „mainstream“)
 - Oracle: checking post-conditions
 - Separate tests for each **alternate path**
 - Tests for violating pre-conditions
- Mainly higher levels (system, acceptance...)

3.2.5 Vásárlás

ID / Név:	UC6 / Buy
Verzió:	1.0
Leírás:	A felhasználó a megvásárolni kívánt könyvek kosárba tétele után kifizetheti azokat, ha megad ehhez egy érvényes bankkártya számot, amiről a vételár levonható.
Előfeltétel:	Van legalább egy könyv a felhasználó kosarában, megadott egy érvényes bankkártya számot a kosár megtekintésénél és ezt követően nem navigált el a kosár tartalmát listázó oldalról.
Utófeltétel:	Az ügyfél kosara kiürül, és a könyveket megvásárolja.
Trigger:	A felhasználó a fizetés funkciót választja.
Normál lefutás:	<ol style="list-style-type: none"> 1. A kosárban lévő könyv példányok kikerülnek az adatbázisból. 2. A kosár is kiürül. 3. A fizetés ténye belekerül a tranzakció naplóba.
Alternatív lefutások:	- Ha nincs megadva vagy érvénytelen a bankkártya szám, akkor nem változik sem a készleten lévő, sem a kosárban lévő könyvek listája.

Summary

Requirement analysis

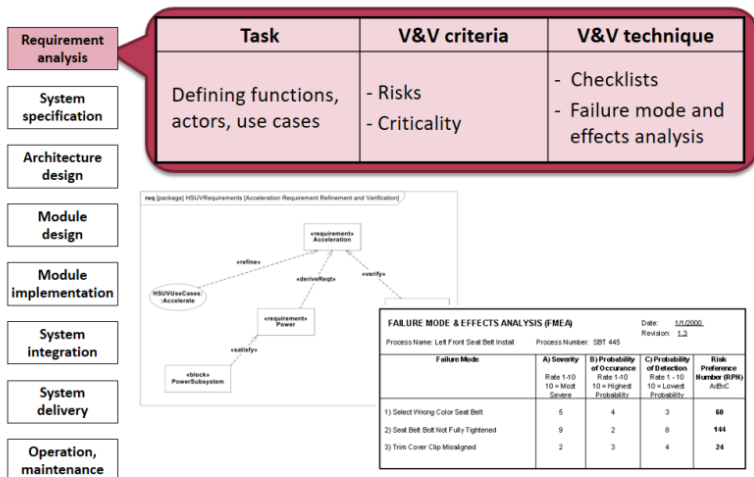

V&V in the V-model

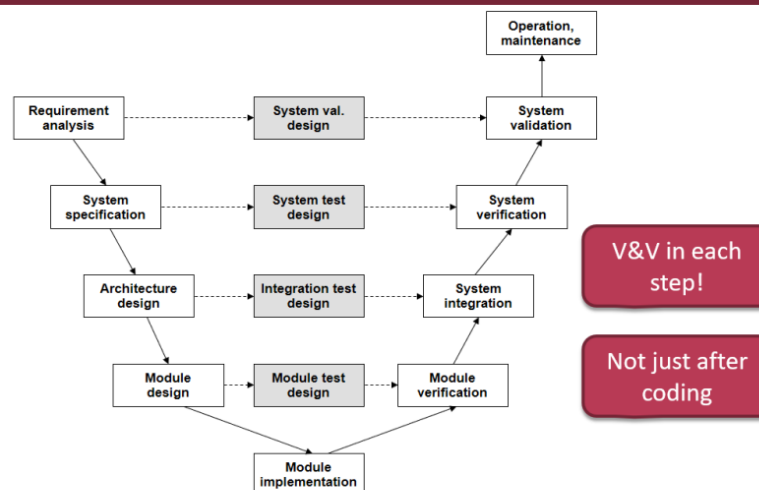

Test design techniques

Goal: Select test cases based on test objectives

Specification-based

- SUT: black box
- Only spec. is known
- Testing specified functionality

Structure-based

- SUT: white box
- Inner structure known
- Testing based on internal behavior

Specification-based techniques

Equivalence classes

Boundary values

Based on use cases

Combinatorial testing

Decision tables

...