

Introduction to Plug-in Development

Eclipse Based Development and Integration

<http://www.inf.mit.bme.hu/edu/courses/eafi>

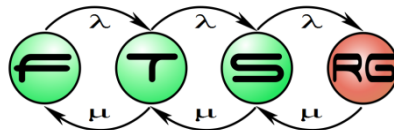

Eclipse: Open IDE and Platform

Why Eclipse?

- Strong industrial support
 - IBM, BEA, Oracle (partially)...
- Many successful development
 - Both industrial and research
- Well-designed architecture
 - Modular design (OSGi)
 - Application of design patterns

Why Eclipse?

- Integrated Development Environment (IDE)
 - Multiple languages (Java, C/C++, PHP, ...)
 - Graphical editors (pl. UML editor)
 - Connectors to issue trackers, ...
- Open source
- **Extensive modeling support**

Eclipse: Development Environment

The screenshot displays the Eclipse IDE interface for a Java project named "BankingProject". The main editor shows the file `BankAccountTests.java` with the following code:

```
package org.eclipse.samples.banking;

import java.math.BigDecimal;

import org.junit.Test;
import static org.junit.Assert.*;

public class BankAccountTests {
    @Test
    public void testDeposit() throws Exception {
        BankAccount account = new BankAccount();
        account.deposit(new BigDecimal(1000));

        assertEquals("...", 1000, account.getBalance());
    }
}
```

A context menu is open over the `account.deposit` call, offering actions like "Create method 'deposit(BigDecimal)' in type 'BankAccount'", "Add cast to 'account'", and "Rename in file". A yellow tooltip on the right shows the stub for the `BankAccount` class:

```
import java.math.BigDecimal;

public class BankAccount {

    public void deposit(BigDecimal bigDecimal) {
        // TODO Auto-generated method stub
    }
}
```

The "Problems" view at the bottom shows three errors:

Description	Resource	Path	Location
Syntax error, insert ";" to complete	BankAccountTests.java	BankingProject/src/org/eclipse/samples/banking/BankAccountTests.java	line 15
The method deposit(BigDecimal) is undefined for the type BankAccount	BankAccountTests.java	BankingProject/src/org/eclipse/samples/banking/BankAccountTests.java	line 13
The method getBalance() is undefined for the type BankAccount	BankAccountTests.java	BankingProject/src/org/eclipse/samples/banking/BankAccountTests.java	line 15

The status bar at the bottom indicates: "The method deposit(BigDecimal) is undefined for the type BankAccount | Writable | Smart Insert | 13 : 18".

Eclipse: Application Platform

- Rich Client Platform (RCP)
 - Desktop application platform
 - Same extension mechanism as the IDE
 - IDE plug-ins reusable
 - In fact, Eclipse IDE is a specific RCP application
 - Framework for application integration
 - E.g., Lotus Symphony office software
- Rich Ajax Platform (RAP)
 - Web application platform
 - Goal: Single sourcing with RCP

RCP application - XMIND

The screenshot displays the XMIND 2007 application window. The main workspace shows a mind map with a central node 'Sitemap' and several branches:

- Solutions**: Includes sub-nodes for 'Individual' (Presentation, Decision Maker, Writing Helper, Time Management), 'Education' (Innovation, Teaching, Key Notes), and 'Teamwork' (Brainstorming).
- Home**: Includes 'What's New'.
- Products**: Includes 'Overview', 'Screenshots', 'Tech Notes', 'Downloads', and 'Purchase'.
- Support**: Includes 'FAQ', 'Install', and 'Forum'.
- About**: Includes 'Pictures', 'Map', and 'Privacy'.
- Analytics**: Includes 'Pageviews', 'Visits', and 'PV' (linked to 'By Google').
- Next Version**: Includes 'Solutions', 'Tech Notes', 'Downloads', and 'Cases'.
- Features**: Includes a list of 11 features and a sub-node 'Four Special Features'.

The right sidebar contains several panels:

- Outline**: Shows a hierarchical tree of the mind map nodes.
- Notes**: A text area for notes.
- Markers**: A filter panel with 'XMIND Markers' and various icons like Priority, Smiley, Task Complete, and Flags.

The bottom of the window shows a 'Properties' panel with 'Templates' and a row of six template thumbnails: Default Template, XMIND Classic, XMIND Simple, XMIND Business, XMIND Academese, and XMIND Comic. The status bar at the bottom indicates '1 topic(# Sitemap *) selected.'

RCP application- Kalypso

The screenshot displays the Kalypso software interface. The main window shows a map of a catchment area with subcatchments highlighted in red. The interface includes a Navigator, Style Editor, and a table of subcatchment data.

Style Editor: Subcatchments

Regel: + + - ←

Subcatchments | Subcatchments-Numb

Titel: Subcatchments

MinDenom: 0.0

MaxDenom: 77277.838217127

Symbolizer: Polygo Ort

Legende:

Polygon | Line | Point | Text

Füllung

Fill-Farbe:

Fill-Opacity: 0.2

Outline:

+ Legende

+ Knoten

+ VGewaesser

+ KMGewaesser - aktiv

+ RHBGewaesser

Teilgebiete

+ Subcatchments

Hydrotoper

+ hydrotoper

Table: *Tabelle_Teilgebiete.gtt

TG-Nummer (in...	Versiegelu...	Anstie...	TG-Flaeche (fla...	Faktor ...	Anfangsinhalt ...
100	0.188		1123080		
101	0.0080				
102					
				2.0	
				1.5	

<http://www.kalypso-simulation-platform.org>

RAP application– Yoxos OnDemand

The screenshot shows a web browser window titled "Yoxos OnDemand – Get your personalized Eclipse". The address bar shows the URL "http://ondemand.yoxos.com" and the search term "RAP application". A warning message states "This web site does not supply identity information." The main content area is divided into several sections:

- Components:** A sidebar with a search bar and a tree view of Eclipse components. The tree is expanded to show various categories like "Managed Templates", "C and C++ Development", "Charting and Reporting", "Communications", "Database Development", "Desktop", "Eclipse Development", "Graphical Editors and Frameworks", "Java Development", "Mobile Java", "Models and Model Development", "Mylyn", "Other Tools", "Programming Languages", "Quality Assurance", "Remote Access and Device Development", "Runtime", "SOA Development", "Science", "Source Code Management", "Sources", "Testing and Performance", "UI Development", "Web and Java EE Development", and "Yoxos Tools".
- Plan:** A central area where users can select features for their download. It shows "MacOS X Cocoa" selected in a dropdown menu. Below this, it states "No components are selected for installation." and "Use the Add button to insert contents into the Plan." There are also buttons for "Add Shared Template", "Save As Template", and "Start Download".
- Information:** A section with tabs for "Information" and "License". It contains the text "Select elements from other views to display their information."
- Get Certified Components:** A promotional banner for "YOXOS SecunSource" with a "Feedback" button and the text "At a special introductory price until December 1st."
- Cheat Sheets:** A section titled "Yoxos OnDemand: Free Eclipse Download Service" with an "Introduction" section. The introduction text reads: "Discover the Yoxos OnDemand Services: Create a custom download by selecting your favorite plugins or create a profile consisting of plugins AND team project sets, preferences, mylyn queries and more. We combine everything into a **single download** that you simply extract to create your personal Eclipse installation." Below this is a "Click to Begin" button and a list of steps: "Selecting your Operating System", "Getting", and "Automated dependency".

Modeling in Eclipse

Model-driven architecture

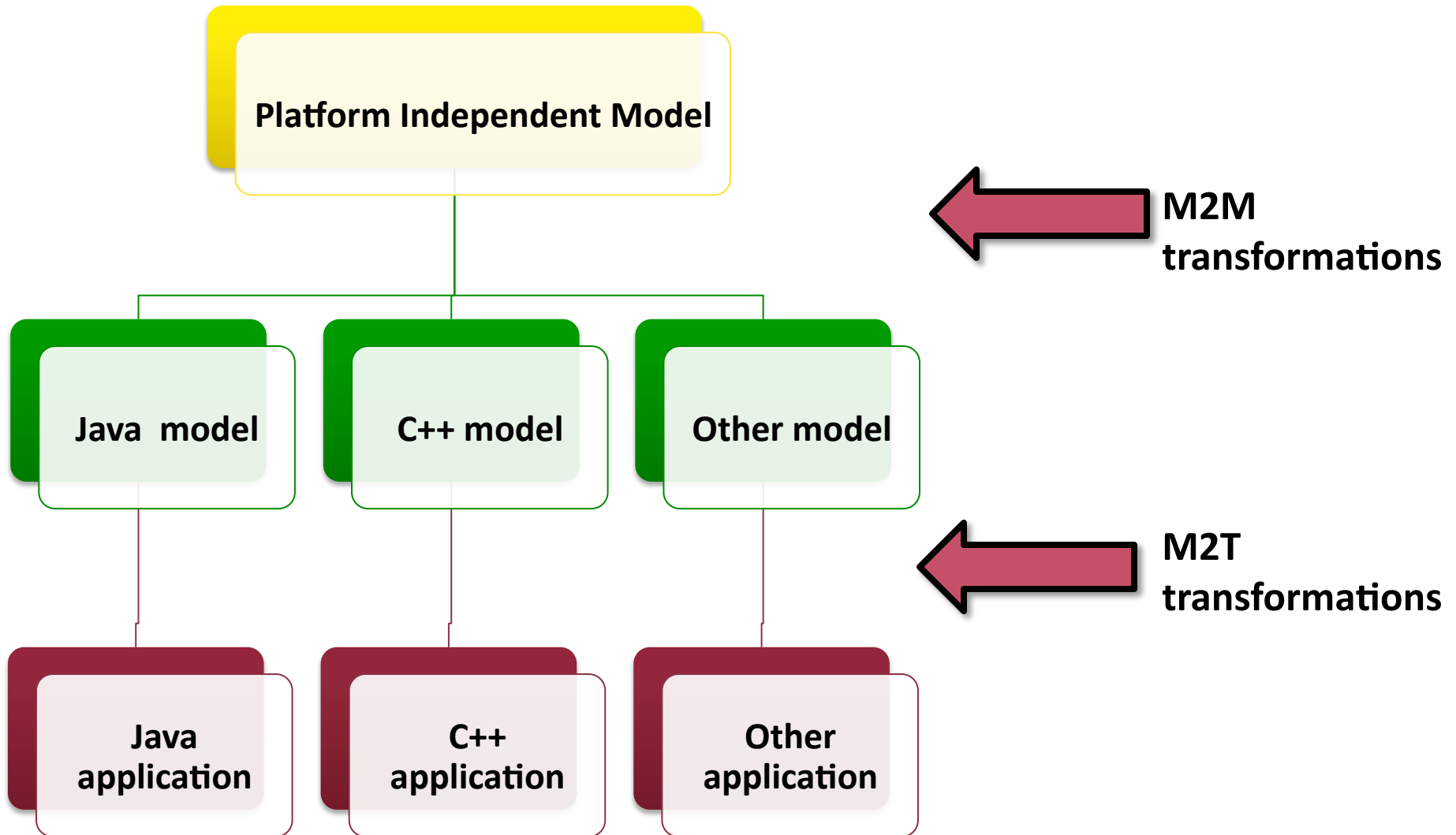

Motivation

- Domain-specific modeling
 - Dedicated modeling environments needed
 - Tool support is critical
 - Integration platforms
- Goal
 - Extensible development environment (Eclipse)
 - Modeling and application development together

Tool support

- Modeling environment
 - Editing **textual models**
 - Editing **graphical models**
- Correctness issues
 - **Metamodeling**
 - Validation
- Processing models
 - Conversion to text: **code** and configuration **generation**
 - Conversion to other models: **model transformation**
 - **Model execution**

Eclipse Modeling Project

- Eclipse 4.2 (Indigo)
 - 50+ projekt és alprojekt
- További projektek
 - Több-kevesebb támogatás
 - Korai fejlesztési fázisban (incubation)
- Jó néhány előkerül a tárgy során

Eclipse Modeling Project

Eclipse Modeling Project	✓	●	🗨️	📄	●	
Amalgam	🥚	●	🗨️	📄	●	?
Agent Modeling Platform (AMP)	🥚	●	🗨️	📄	●	?
Eclipse Modeling Framework (EMF)	✓	●	🗨️	📄	●	?
Modeling Workflow Engine	✓					
Eclipse Model Framework Technology (EMFT)	🥚	●	🗨️	📄	●	?
B3	🥚	●	🗨️	📄	●	
Graphical Modeling Project	🥚					
Graphiti	🥚	●	🗨️	📄		
Generative Model Transformer (GMT)	🥚	●	🗨️	📄	●	
Model-to-Model Transformation	🥚	●	🗨️	📄	●	
Model-to-Text Transformation (M2T)	🥚	●	🗨️	📄	●	?
Model Development Tools (MDT)	🥚	●	🗨️	📄	●	?
Presentation Modeling Framework (PMF)	🥚	●	🗨️	📄	●	
Textual Modeling Framework	🥚		🗨️			

UML

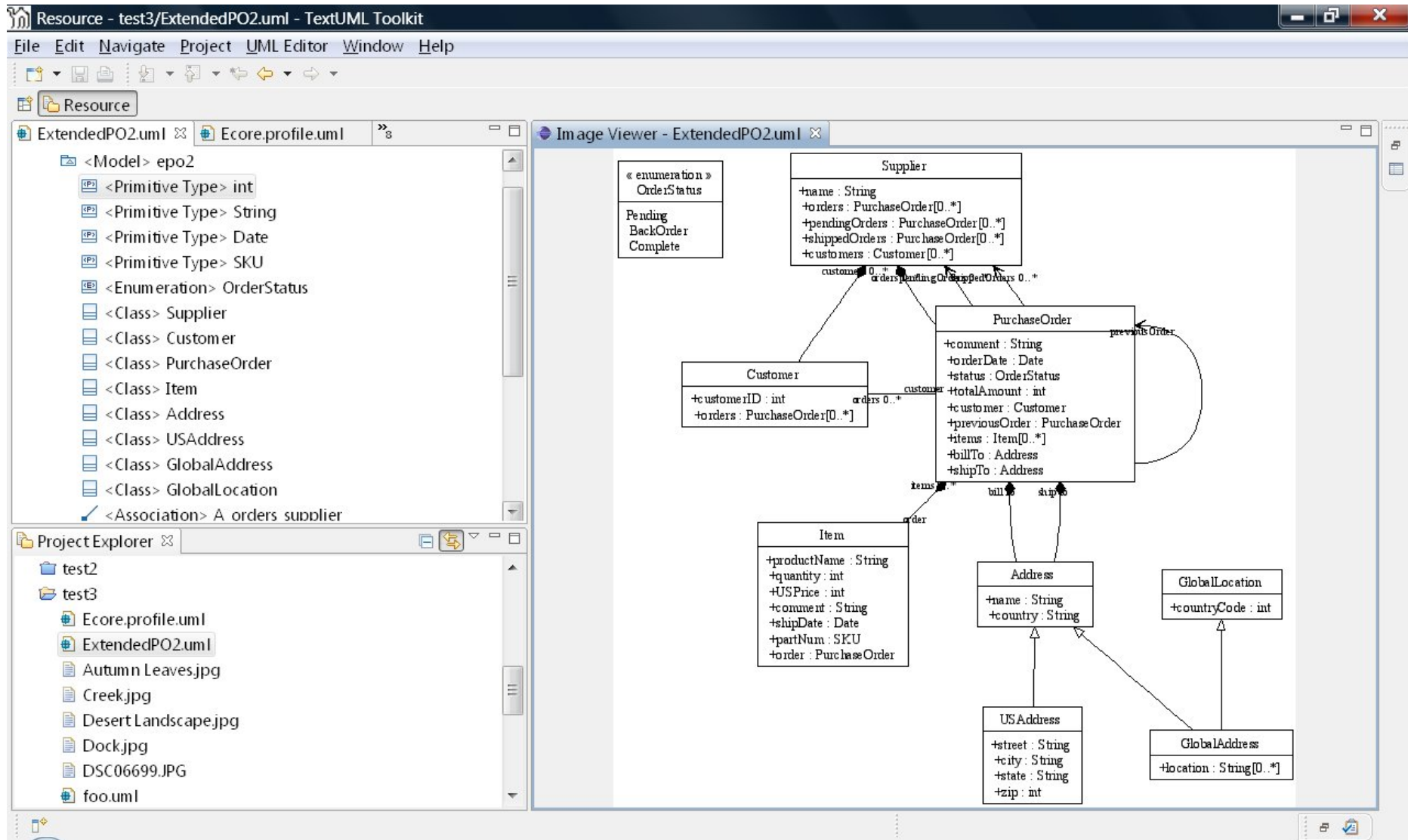

SysML

1. Structure

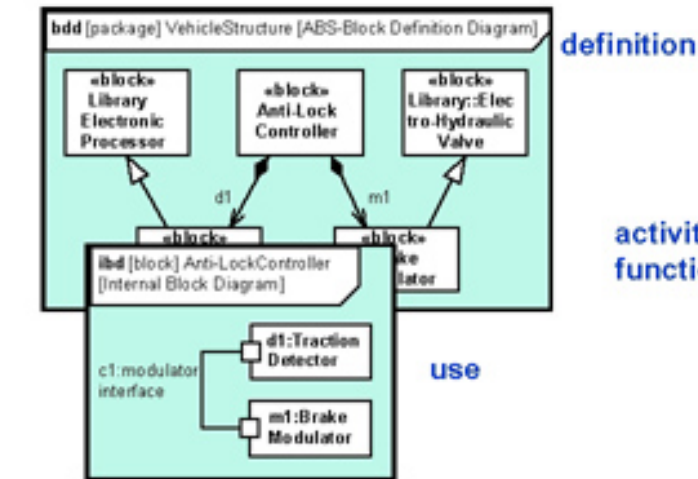

2. Behavior

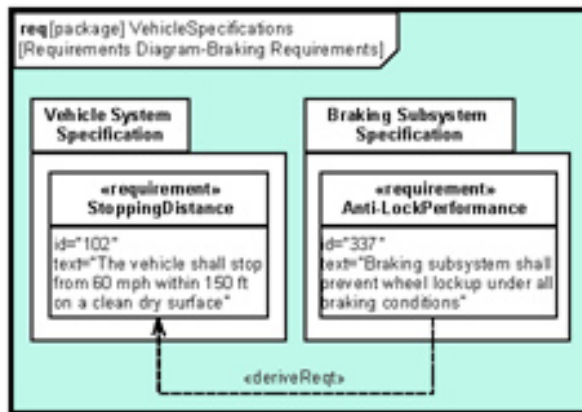
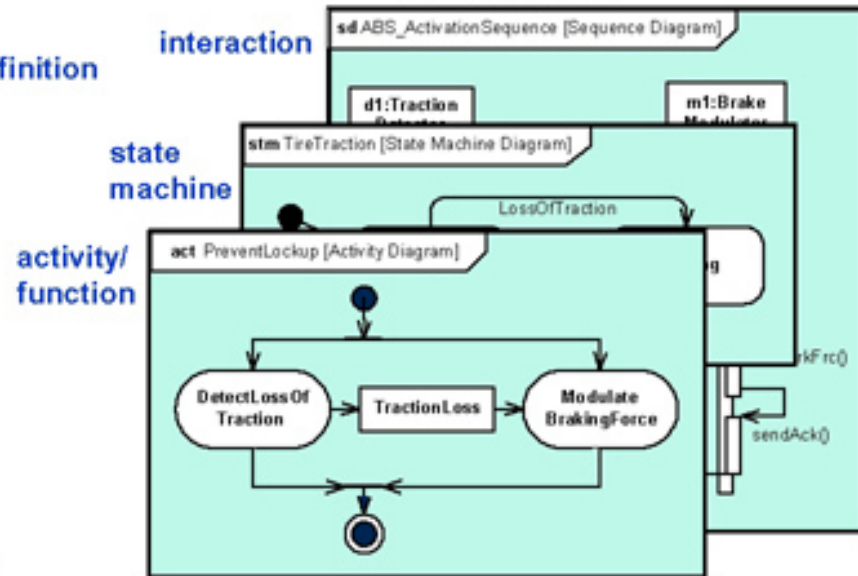

4. Parametrics

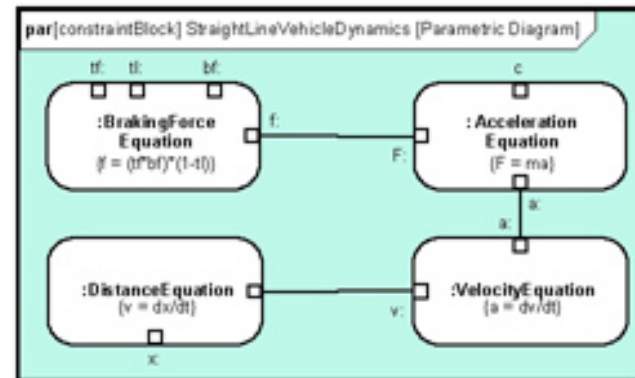

3. Requirements

Note that the Package and Use Case diagrams are not shown in this example, but are respectively part of the structure and behavior pillars

Workflow

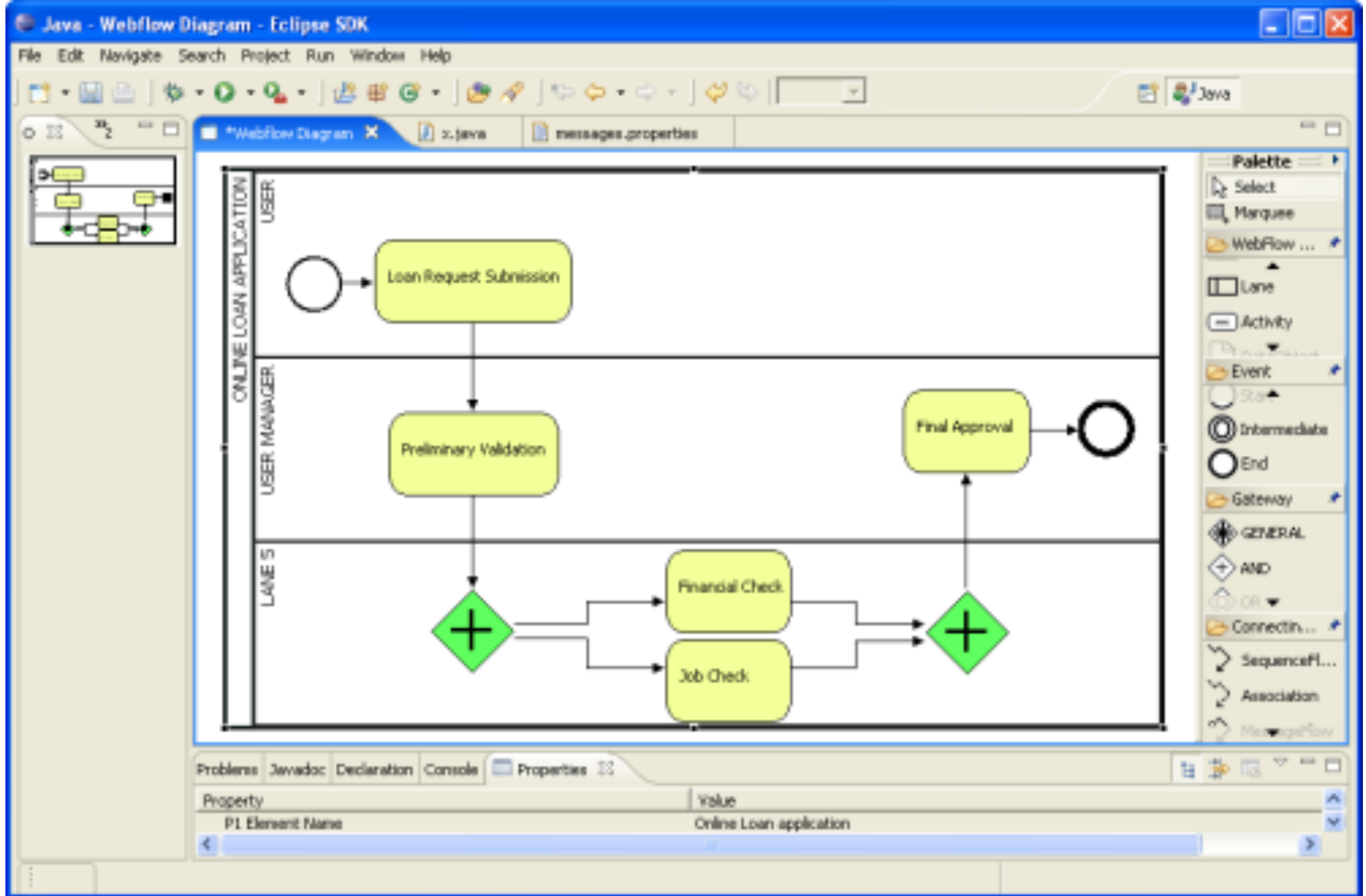

AADL

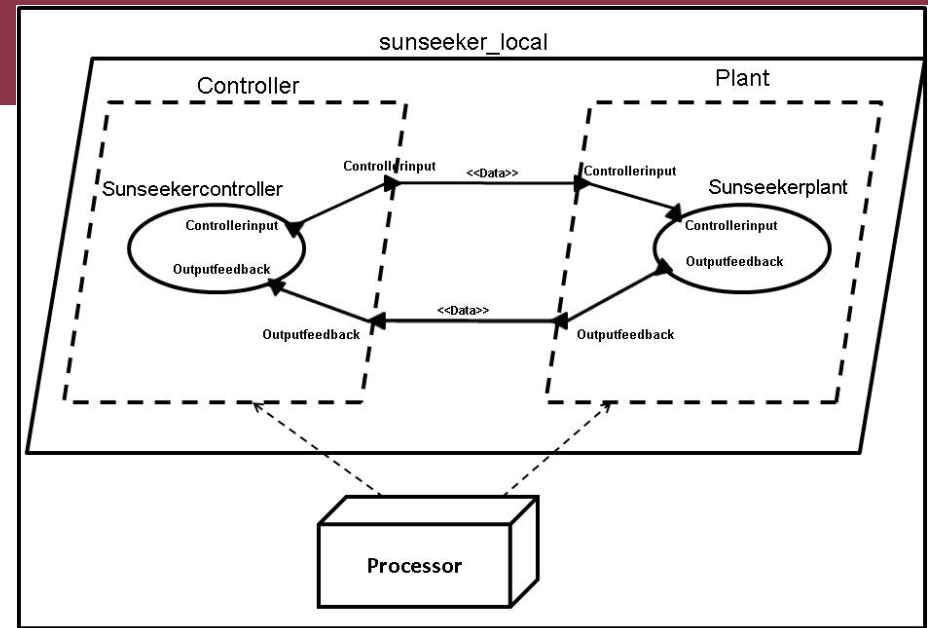
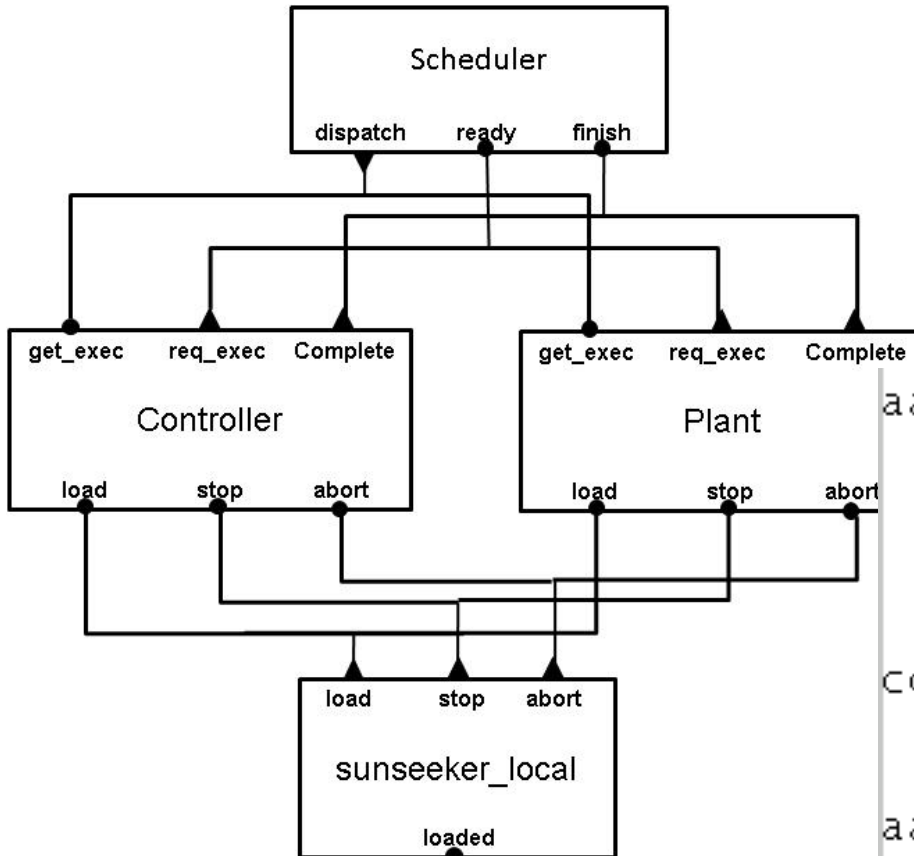

```

aadl_specification :
aadl_declaration
| cotre_directive
| aadl_specification aadl_declaration
| aadl_specification cotre_directive ;
    
```

```

cotre_directive :
IMPORT string_literal ';;'
    
```

```

aadl_declaration :
component_classifier
| system_instance
| property_set ;
    
```

The first steps

Download

- www.eclipse.org/downloads
- Free and open source
 - Available for most platforms
- Current version
 - Eclipse 4.3.0 (codename Kepler)
 - 4.3.1 available on 27th September

Downloadable packages

- Multiple packages available for downloads
 - Eclipse IDE for Java EE Developers
 - Eclipse IDE for Java Developers
 - Eclipse for PHP Developers
 - Eclipse IDE for C/C++ Developers
 - Eclipse for RCP/Plug-in Developers
 - **Eclipse Modeling Tools**
 - ...
- A package can be “updated” to another via Update manager

First homework

- Install Eclipse 4.3 (Kepler)
 - Helpful for the semester 😊
 - Do include modeling projects

Eclipse Modeling Tools Package

- Java Developer Tools (JDT)
- Plug-in Developer Tools (PDT)
 - Including plug-in sources
- Eclipse Modeling Platform (EMF)
 - Modeling support
- Mylyn, CVS, Git
 - Team work support
- Help
- Update
 - Marketplace Client
 - Modeling Discovery

Eclipse Modeling Tools Package

- Java Developer Tools (JDT)
- Plug-in Developer Tools
 - Including plug-in sources
- Eclipse Modeling Platform
 - Modeling support
- Mylyn, CVS, Git
 - Team work support
- Help
- Update
 - Marketplace Client
 - Modeling Discovery

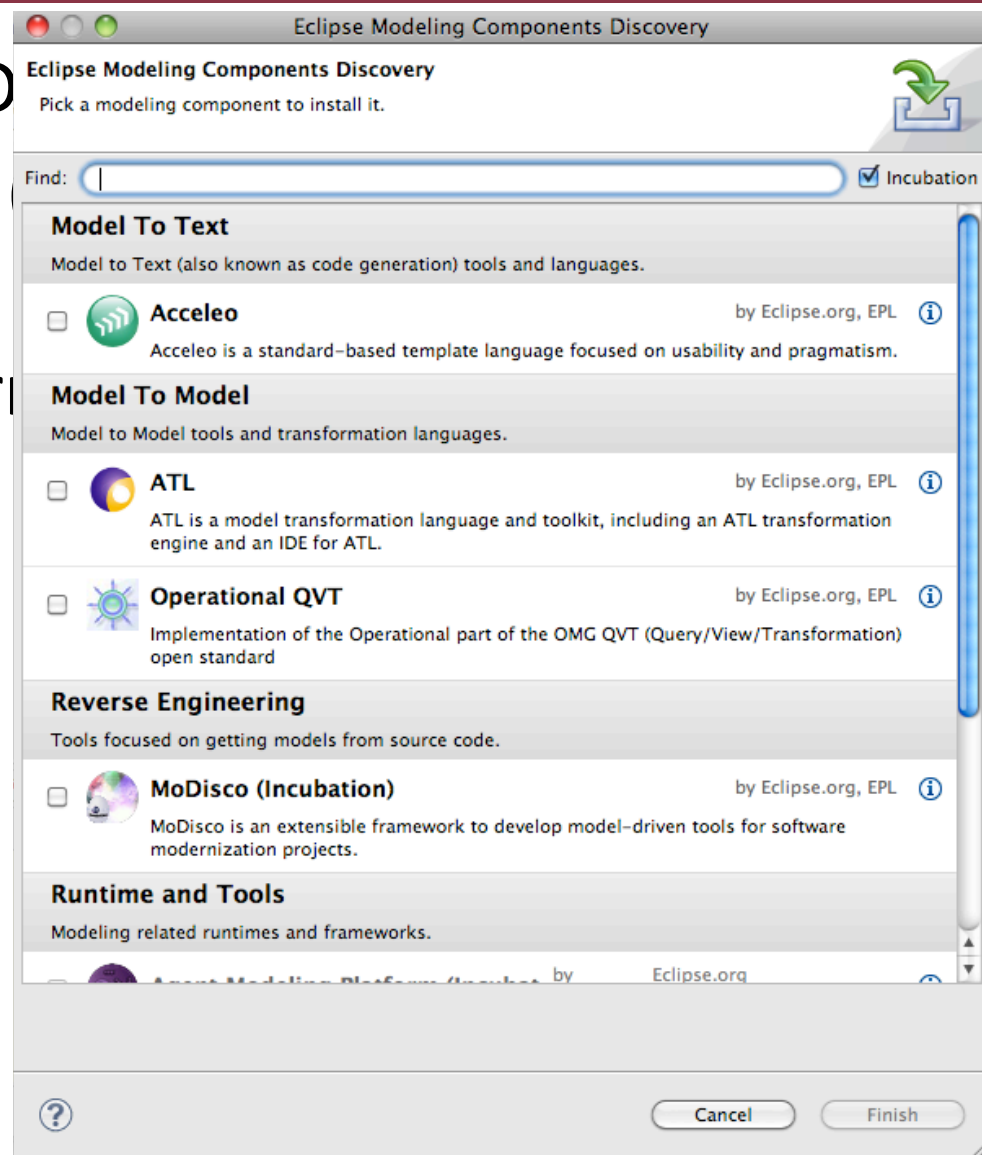

The Plug-in Architecture of Eclipse

Extensible Application

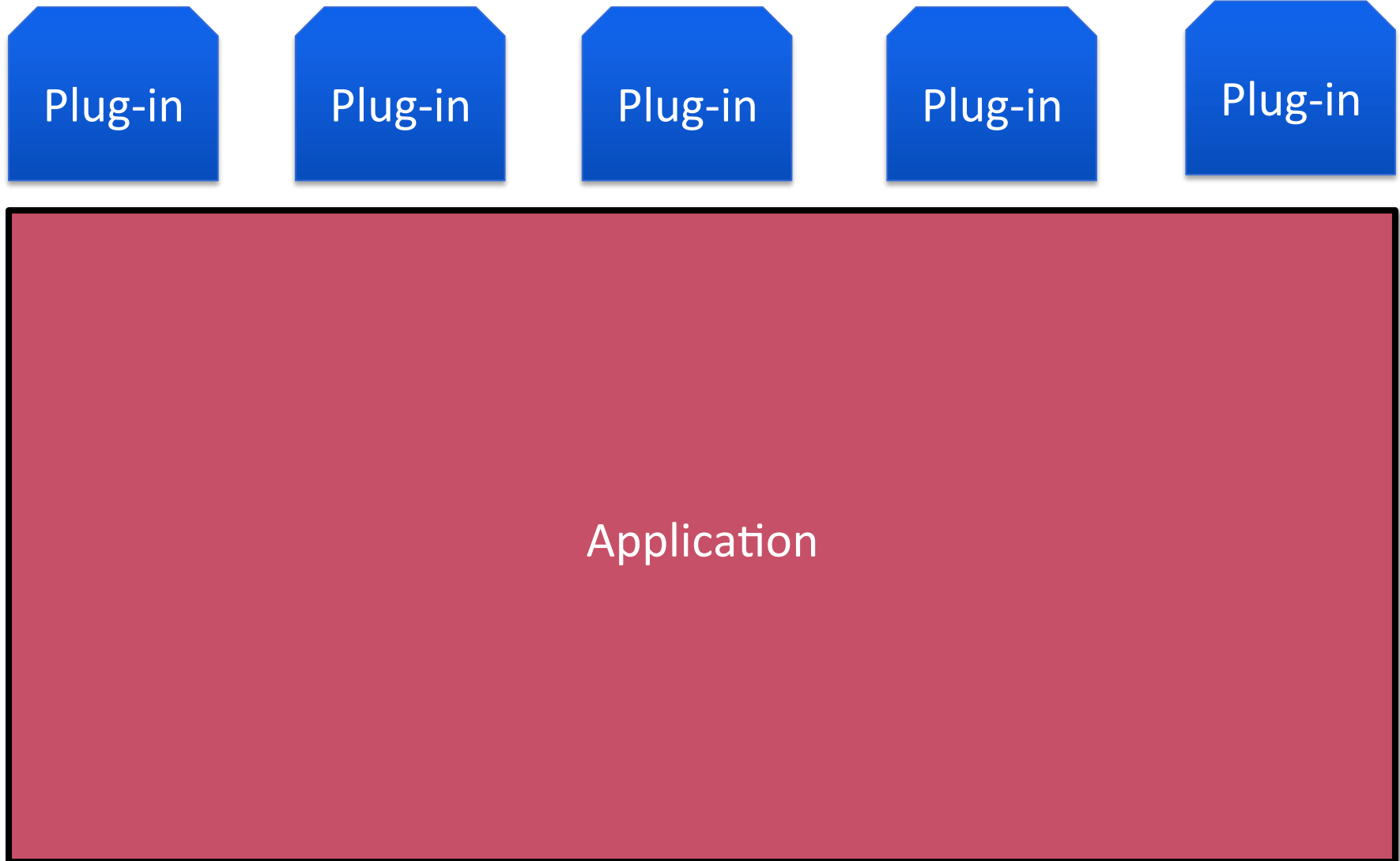

Plug-in Based Application

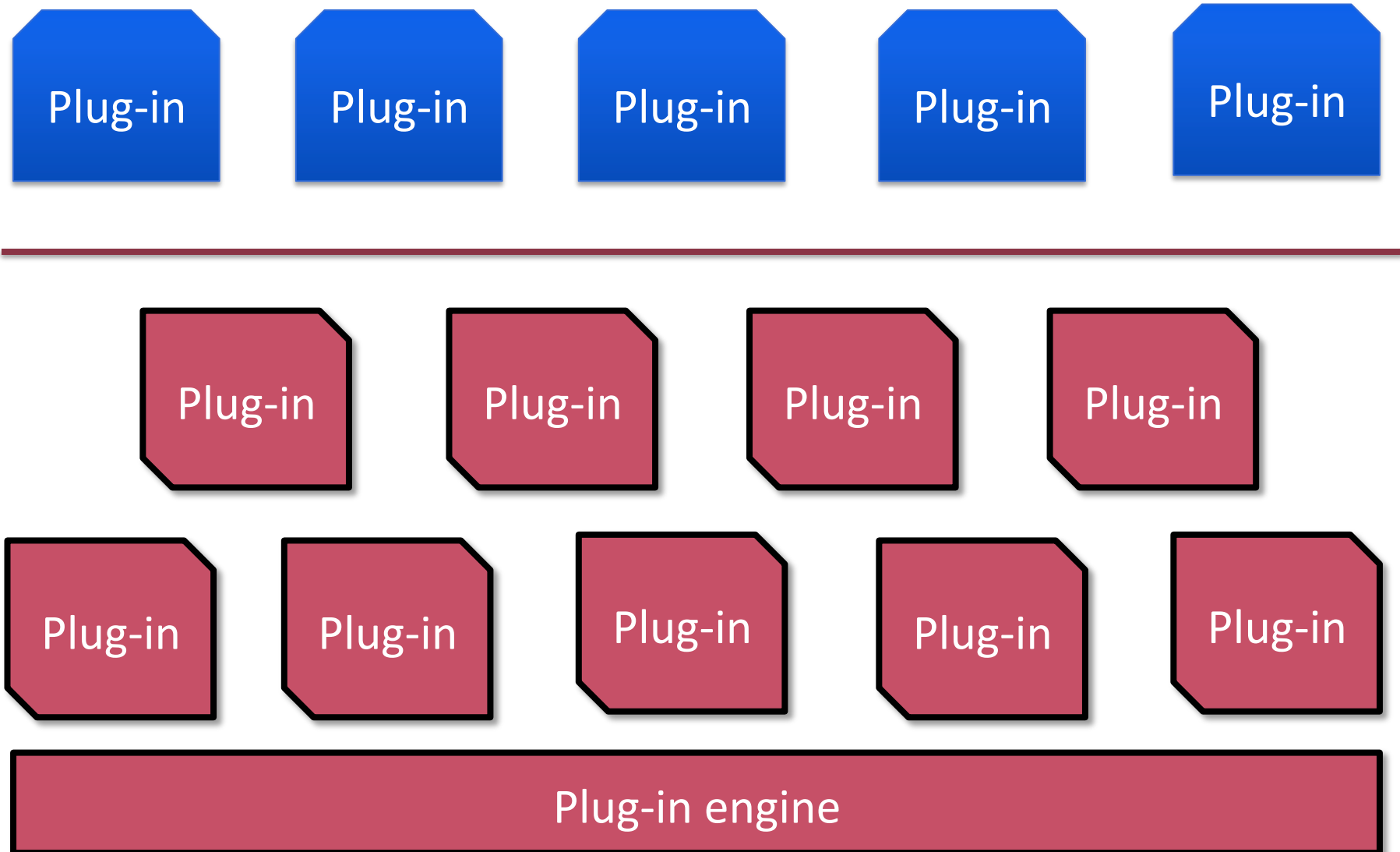

Eclipse Architecture

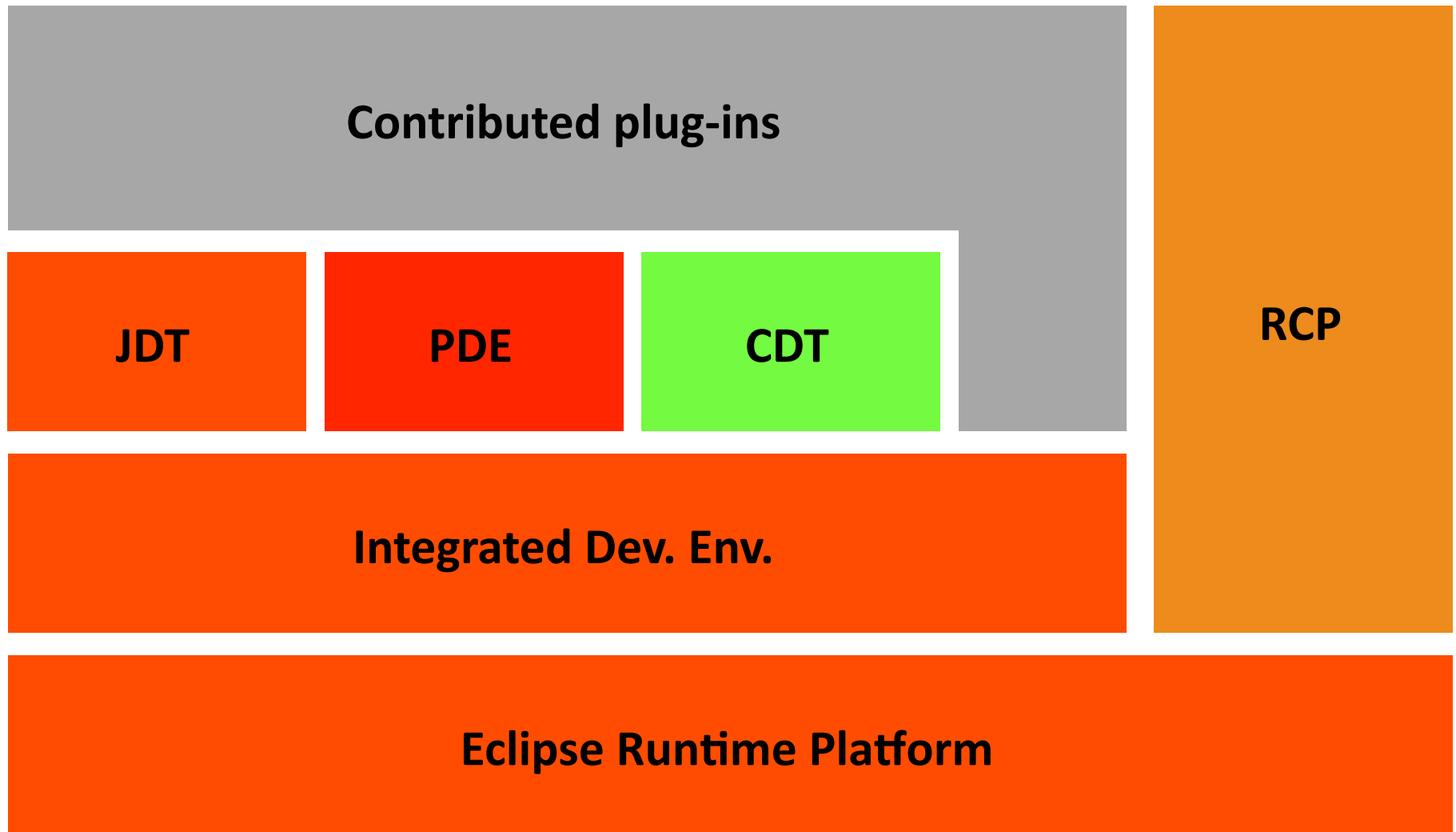

Eclipse Runtime Platform

- Plug-in engine
 - Platform startup
 - Plug-in registry
 - Resource management
- Software updates
- User interface
- Help engine

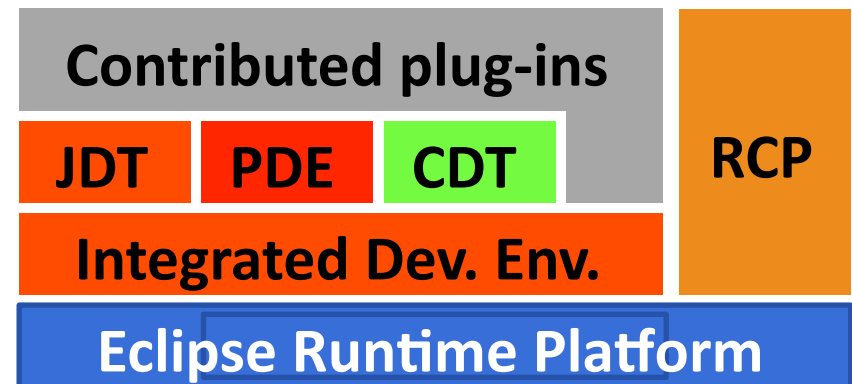

Language-Independent IDE

- Views, perspectives (see later)
- (Language-independent) Search Support
- (Language-independent) Debug Support
- Teamwork support

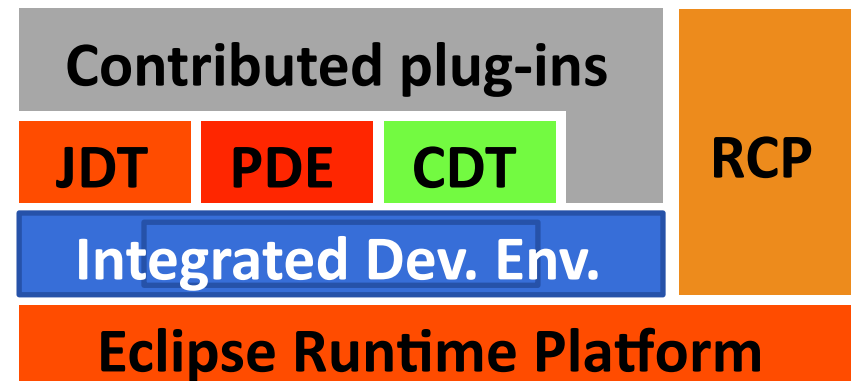

Language-specific Environments

- Java Development Toolkit (JDT)
 - Java Editor, Compiler, Debugger
 - Java Object Model/AST
- Plug-in Development Environment
 - Eclipse plug-in development
- C/C++ Development Tools
 - C/C++ editor
 - External debuggers
 - External compilers

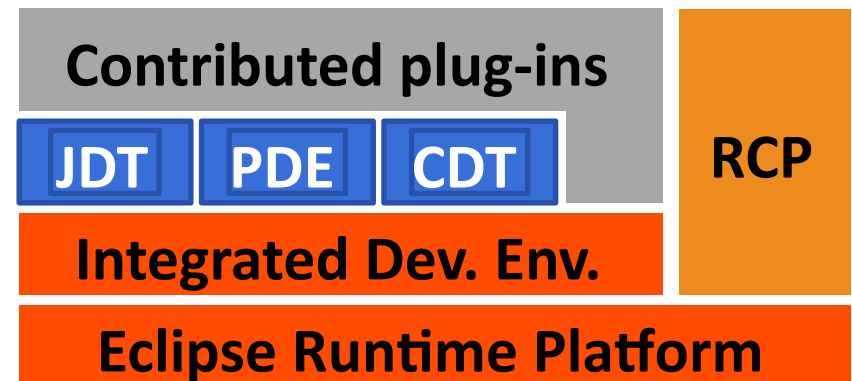

Eclipse Application Platform

- Application Platform
 - Re-useable Services
 - Platform 4.x introduces a new programming model (see later)
- Independent from IDE components
 - But they are re-usable if needed

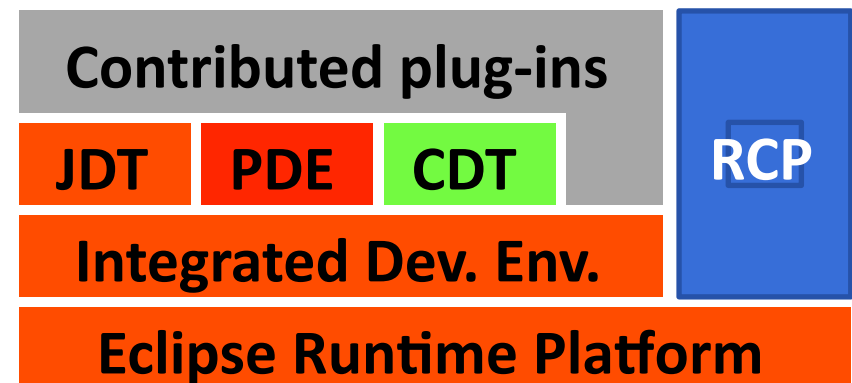

Contributed Plug-ins

- Everything is possible (almost)
- Can re-use anything
 - Beware of dependencies!

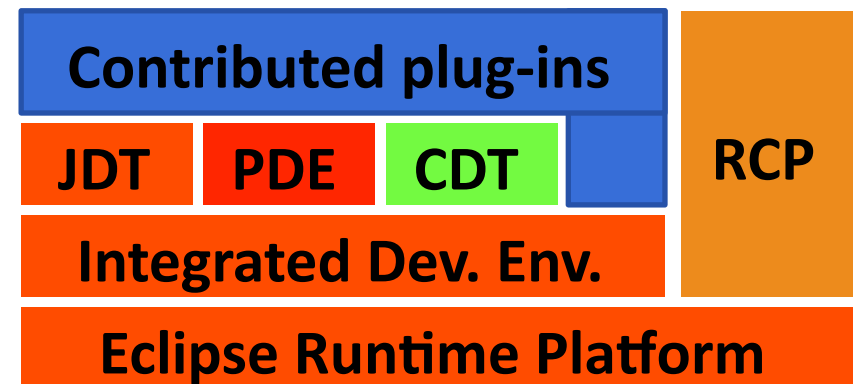

Eclipse Plug-ins

Eclipse Plug-ins (Overview)

- Module concepts
 - Eclipse Plug-ins
 - *OSGi bundles (not in this course)*
- Co-operation
 - Calling API methods
 - Extension points
 - *OSGi services (not in this course)*

Eclipse Plug-in

- Smallest installable unit (sort of)
 - Java code
 - Metadata (descriptors)
- Packaging/distribution
 - jar archives
 - Recompiling existing libraries to plug-ins manageable
- Extension
 - Features: a group of plug-ins
 - Used at install (why?)

Lazy loading

- Basic rule
 - „Contributions are only loaded when they are needed.”
 - BUT: Plug-in metadata is always loaded

Most important metadata: Dependencies

Most important metadata: Dependencies

Plug-in 1

Plug-in 2

Plug-in 3

Plug-in 4

Plug-in 5

Most important metadata: Dependencies

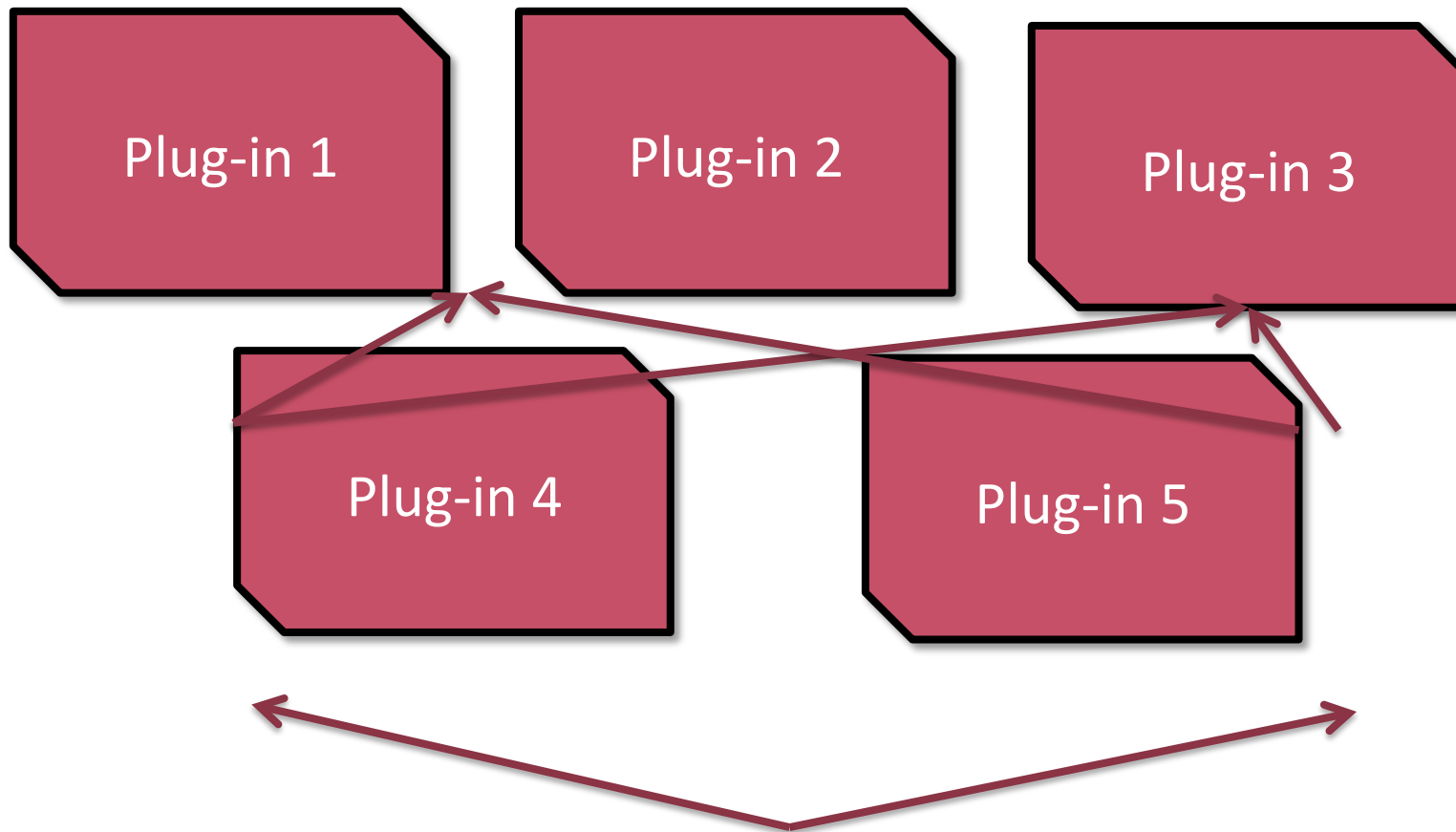

Most important metadata: Dependencies

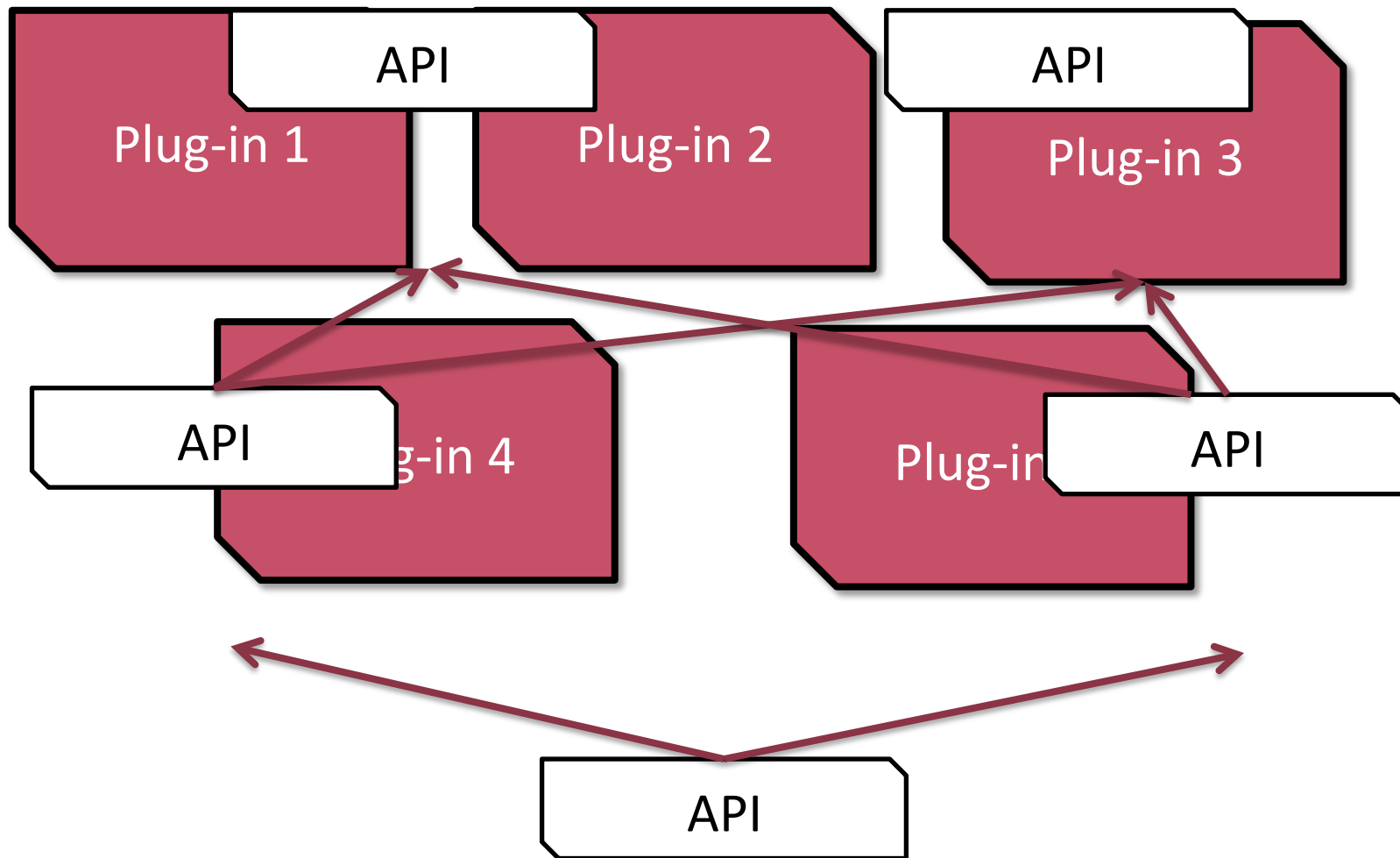

Standard Project Separation

- Core plug-in
 - Mandates API definition
- GUI plug-in
 - Allows headless execution if necessary
- Further plug-ins as necessary
 - In most cases, dependencies define boundaries

API Definition

- List API packages (exported)
 - By default, packages are visible only inside the plug-in
 - Exported packages are also visible in other plug-ins
 - Via dependency definition
- Goal
 - Information hiding
 - Implementation classes not needed

API Design – Rules of Thumbs

- **Explicit API:** *Separate the API from internals*
 - Typically *.internal* packages
- **Stability:** *Once you invite others, don't change it*
 - API changes -> every user has to change
- **Defensive API design:**
 - *Reveal only the API in which you have confidence, but be prepared to reveal more API as clients ask for it.*

Problem with Generic Plug-ins

- Generic GUI extensions (e.g. menu items)
 - Unique labels and event handlers
 - **Must** be implemented in specific plug-ins
 - Unified presentation and management
 - **Should** be implemented in general plug-ins
- Problem
 - Generic plug-in **must not depend on** specific plug-ins
 - Dependency hierarchy/circles
- A solution
 - Extension points

Extension Points

- Eclipse extension point
 - Definer: general plug-in
 - Extension point schema
 - Users: specific plug-ins
 - Configuration
 - Java code
 - Corresponds to schema
 - Dependency to the general plug-in
- Can instantiate non-API classes!

Extension point

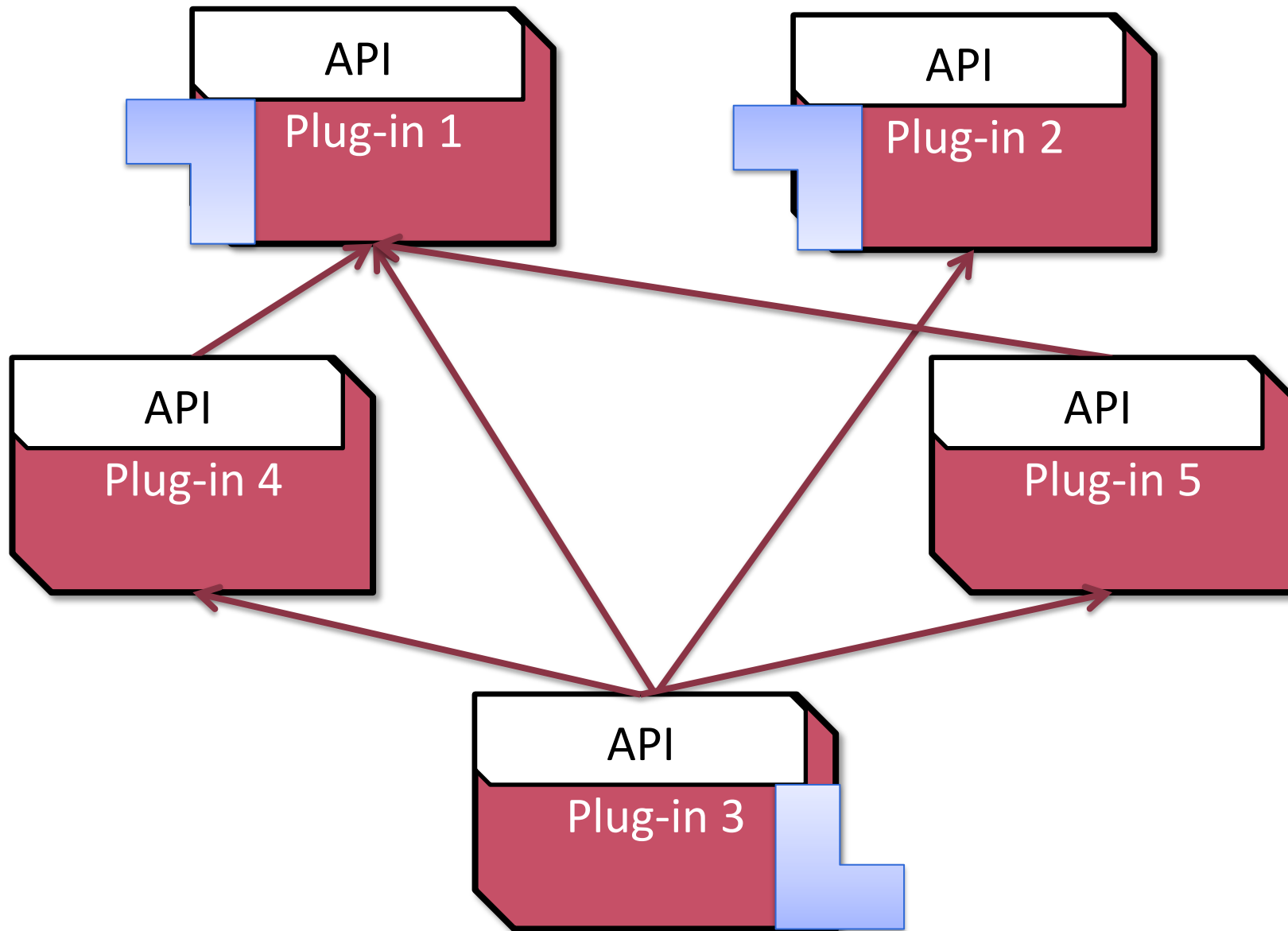

Extension point

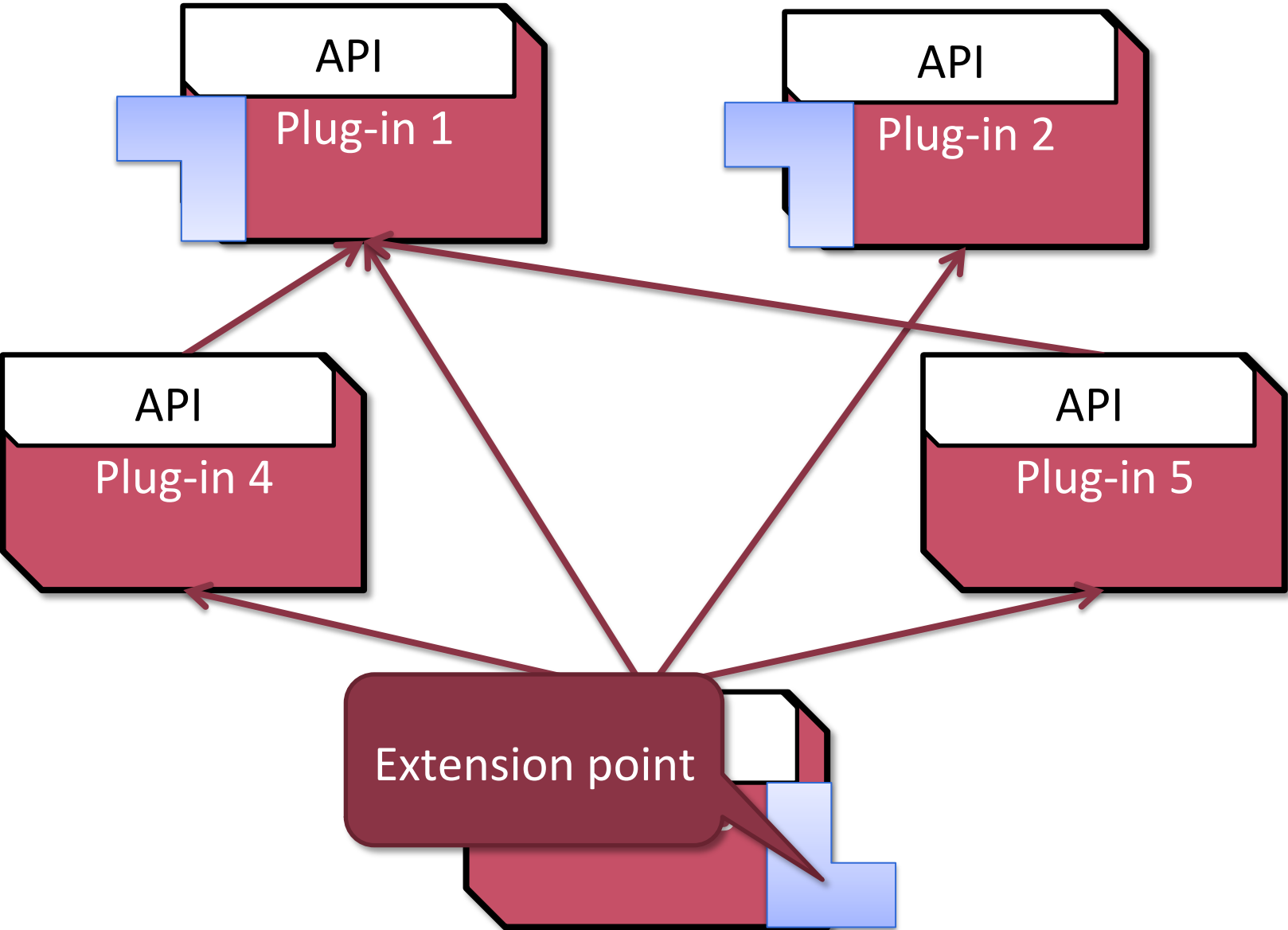

Extension point

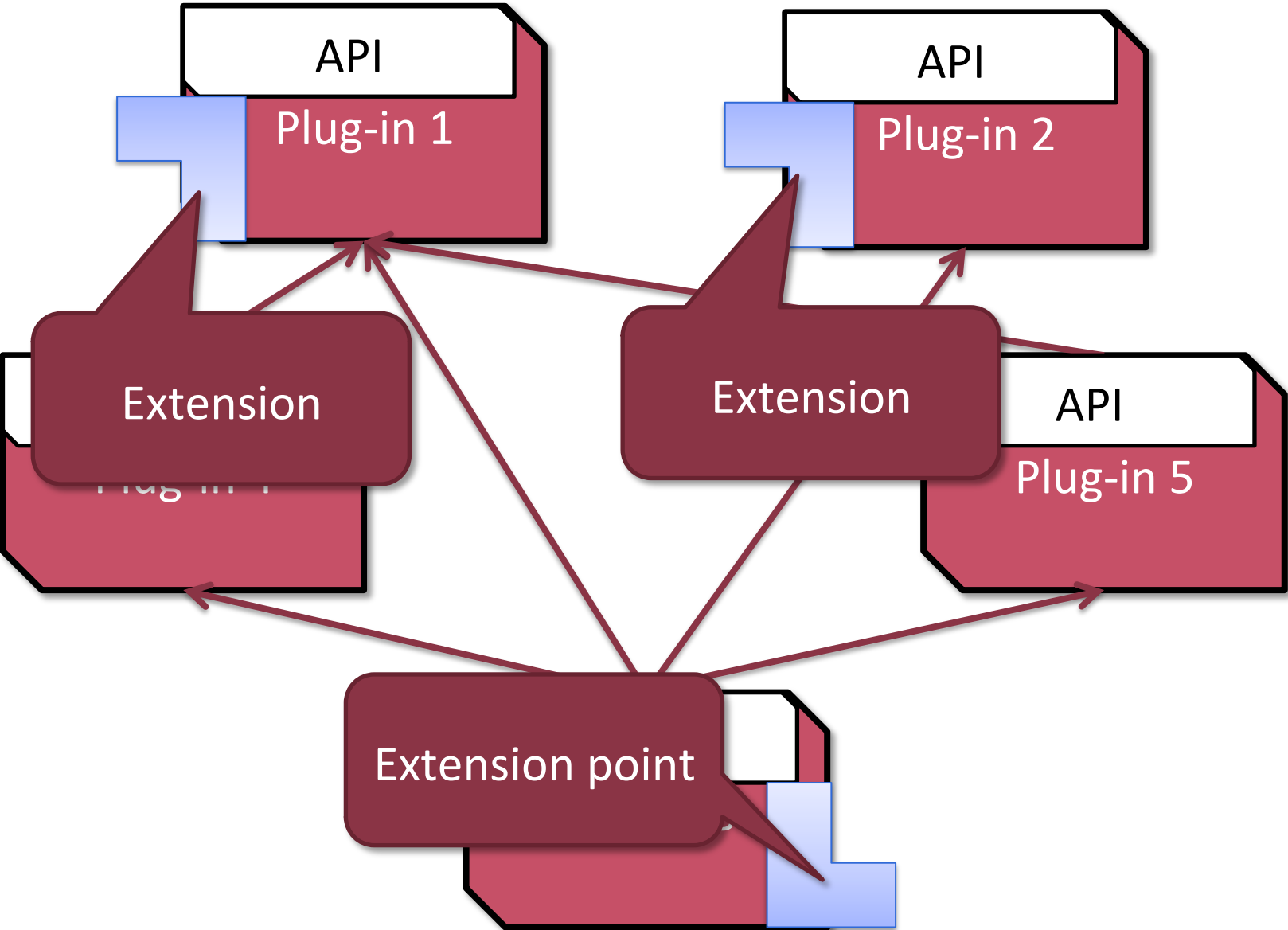

Extension point – Rules of Thumb

- Error management
 - Do not assume correct extensions!
 - *As the provider of an extension point, you must protect yourself against misbehavior on the part of extenders*
- Invitation rule
 - *Whenever possible, let others contribute to your contributions.*
- Documentation
 - Always document the extension points

Extensions – Rules of Thumb

- *Contributions must conform to expected interfaces*
 - Extension must match the extension point definition
- *Share, don't replace*
 - An extension must work with other extensions
 - Do **not** try to exclude other extensions
 - Do not assume there are **no other extensions**
 - Exception:
 - Some extension point assume a single extension
 - Pl. org.eclipse.core.resources.teamHook
 - Extension point documentation!

Extension point - Implementation

- Hogyan használhatjuk fel a kiterjesztéseket?
 1. `IExtensionRegistry`
`Platform.getExtensionRegistry()`
 2. `IExtensionPoint`
`registry.getExtensionPoint(String)`
 3. `IExtension[]` `point.getExtensions()`
 4. `IConfigurationElement`
`extension.getConfigurationElements()`

IConfigurationElement

- Extension parameters
 - Tree structure (like the xml descriptor)
 - Can be validated (extension point schema)
- `String element.getAttribute(String)`
 - Attribute name as parameter
- `Object element.createExecutableExtension(String)`
 - Instantiating classes
 - Can instantiate non-exported classes as well
 - Only parameterless constructors can be used
 - Type casting required

Plug-in Rules of Thumb

- *“Monkey see/monkey do”*
 - *Always copy the structure of a similar plug-in*
 - Template wizards in Eclipse
- Relevance rule
 - *Contribute only when you can successfully operate*
 - Be careful to avoid cluttered user interface
- Follow platform conventions!
 - Re-use existing extensions/services
 - Copy the user interface (if possible)
 - User Interface Guidelines:
 - http://wiki.eclipse.org/User_Interface_Guidelines

Plug-in projects

Plug-in project structure

- Metadata
 - manifest.mf
 - Name, version numbers and dependencies
 - plugin.xml
 - Optional
 - Extension and extension point definitions
- Implementation
 - Java code
- Resources
 - E.g., images, icons, configuration files

Plug-in project structure

■ Metadata

○ manifest.mf

- Name, version numbers and dependencies

○ plugin.xml

- Optional
- Extension and extension point definitions

■ Implementation

○ Java code

■ Resources

○ E.g., images, icons, configuration files

OSGi
convention

Plug-in project structure

■ Metadata

○ manifest.mf

- Name, version numbers and dependencies

○ plugin.xml

- Optional
- Extension and extension point definitions

OSGi
convention

Eclipse specific

■ Implementation

○ Java code

■ Resources

○ E.g., images, icons, configuration files

manifest.mf

- Plugin ID (mandatory)
 - Programmatic identification of the plug-in
- Plugin name (mandatory)
 - Name to display on user interface
- Version number (mandatory)
 - Semantic versioning (next slide)
- Dependencies
 - List of plug-ins (with version numbers)

Semantic versioning

- Fixed format: x.y.z.qualifier
 - x: **major** version
 - an increase signals compatibility breaking change
 - y: **minor** version
 - an increase signals backwards compatible changes
 - z: **patch** version
 - a bugfix release
 - **qualifier**
 - Build identifier number
 - Can be generated automatically
- Version comparison:
 - Comparing each version number as a string
- Example:
 - Last Eclipse 3.4 platform release:
 - 3.4.2.R200902111700

plugin.xml

- Extension point definition
 - XSD schema to define possible extensions
 - String literals, Java class or resource references
 - Mandatory/optional element definition
 - Documentation
- Extension definitions
 - Refers extension point
 - From any visible plug-in (including itself)
 - XML description validated by the extension point schema
 - Java classe and resource references

plugin.xml example

```
<?eclipse version="3.4"?>
<plugin>
  <extension
    point="org.eclipse.ui.commands">
    <command
      description="Shows a Helloworld message."
      id="hu.bme.mit.commanddemo.helloworld"
      name="Display hello world!">
    </command>
  </extension>
  <extension
    point="org.eclipse.ui.handlers">
    <handler
      class="hu.bme.mit.commanddemo.commands.HelloworldHandler"
      commandId="hu.bme.mit.commanddemo.helloworld">
    </handler>
  </extension>
</plugin>
```

plugin.xml example

```
<?eclipse version="3.4"?>
<plugin>
  <extension
    point="org.eclipse.ui.commands">
    <command
      description="Shows a Helloworld message."
      id="hu.bme.mit.commanddemo.helloworld"
      name="Display hello world!">
    </command>
  </extension>
  <extension
    point="org.eclipse.ui.handlers">
    <handler
      class="hu.bme.mit.commanddemo.commands.HelloworldHandler"
      commandId="hu.bme.mit.commanddemo.helloworld">
    </handler>
  </extension>
</plugin>
```

Extension point definition

plugin.xml example

```
<?eclipse version="3.4"?>
<plugin>
  <extension
    point="org.eclipse.ui.commands">
    <command
      description="Shows a Helloworld message."
      id="hu.bme.mit.commanddemo.helloworld"
      name="Display hello world!">
    </command>
  </extension>
  <extension
    point="org.eclipse.ui.handlers">
    <handler
      class="hu.bme.mit.commanddemo.commands.HelloworldHandler"
      commandId="hu.bme.mit.commanddemo.helloworld">
    </handler>
  </extension>
</plugin>
```

Attribute

plugin.xml example

```
<?eclipse version="3.4"?>
<plugin>
  <extension
    point="org.eclipse.ui.commands">
    <command
      description="Shows a Helloworld message."
      id="hu.bme.mit.commanddemo.helloworld"
      name="Display hello world!">
    </command>
  </extension>
  <extension
    point="org.eclipse.ui.handlers">
    <handler
      class="hu.bme.mit.commanddemo.commands.HelloworldHandler"
      commandId="hu.bme.mit.commanddemo.helloworld">
    </handler>
  </extension>
</plugin>
```

Class reference

Form based metadata editor

hu.bme.mit.commanddemo

Extensions

All Extensions

Define extensions for this plug-in in the following section.

type filter text

- ▶ org.eclipse.ui.commands
- ▶ org.eclipse.ui.menus
- ▶ org.eclipse.ui.handlers
- ▶ org.eclipse.ui.commandImages

Add...

Remove

Up

Down

Extension Details

Set the properties of the selected extension. Required fields are denoted by "*".

ID:

Name:

- [Show extension point description](#)
- [Open extension point schema](#)
- [Find declaring extension point](#)

Overview Dependencies Runtime **Extensions** Extension Points Build MANIFEST.MF plugin.xml build.properties

Executing Eclipse Plug-ins

Target Platform

- A set of plug-ins
- Contains the developed plug-ins dependencies for
 - Compiling
 - Execution
- Different platforms for
 - IDE plug-ins
 - RCP applications
 - RAP applications
- Custom platforms possible

Plug-in Execution

- Execution classpath contains
 - Developed plug-ins
 - Target platform
- IDE plug-in
 - A new Eclipse workbench is started
- RCP/RAP application
 - The defined application starts

Execution

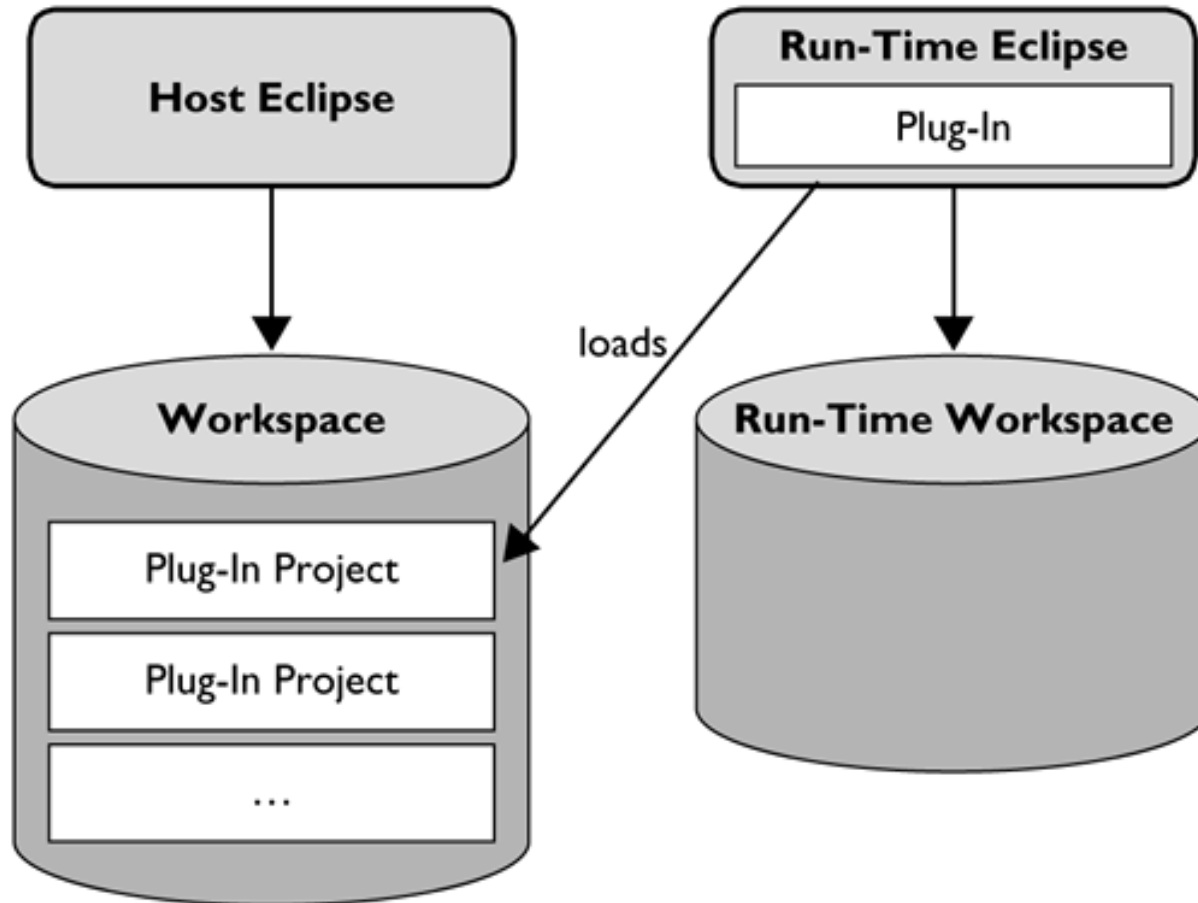

Execution

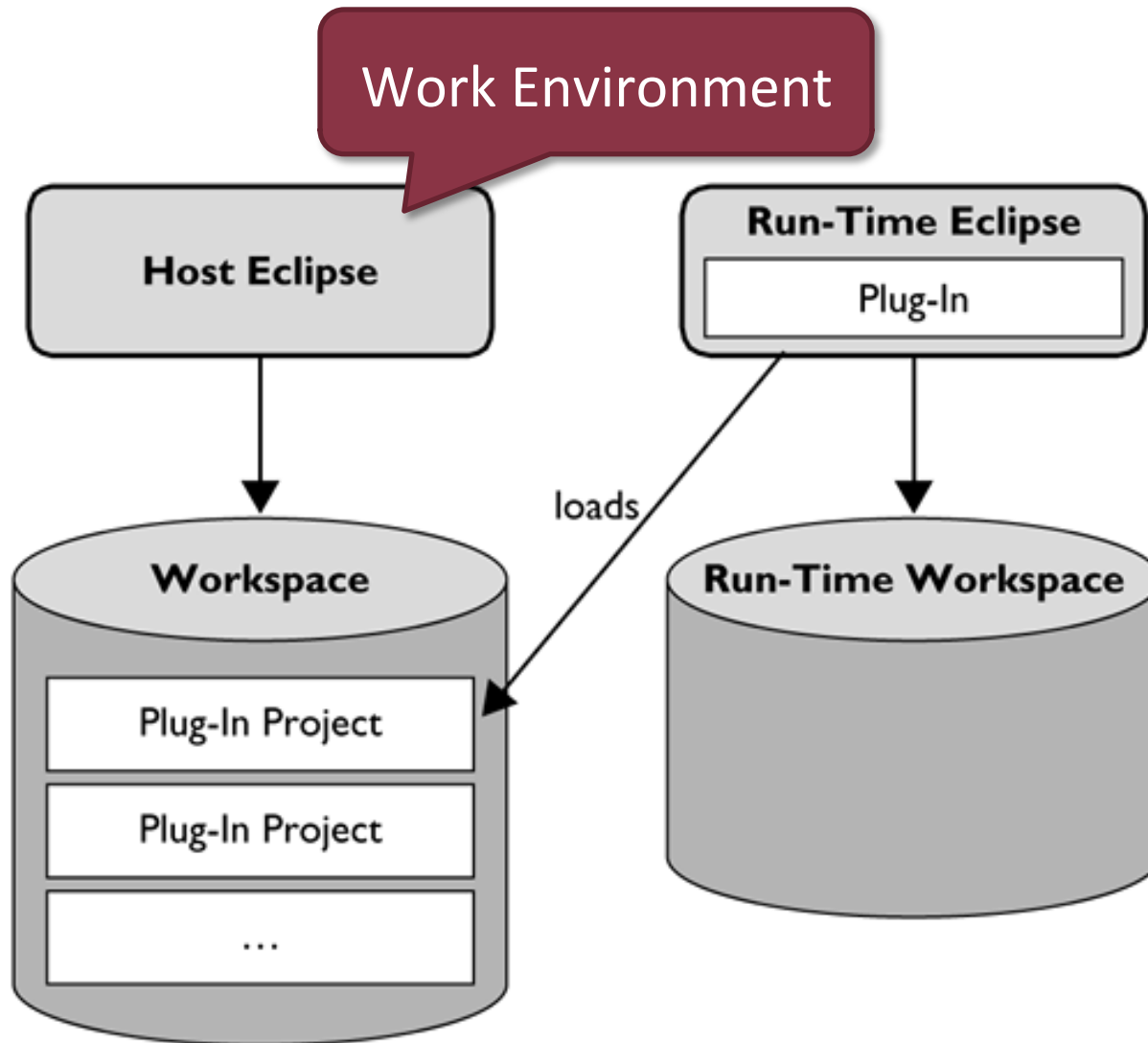

Execution

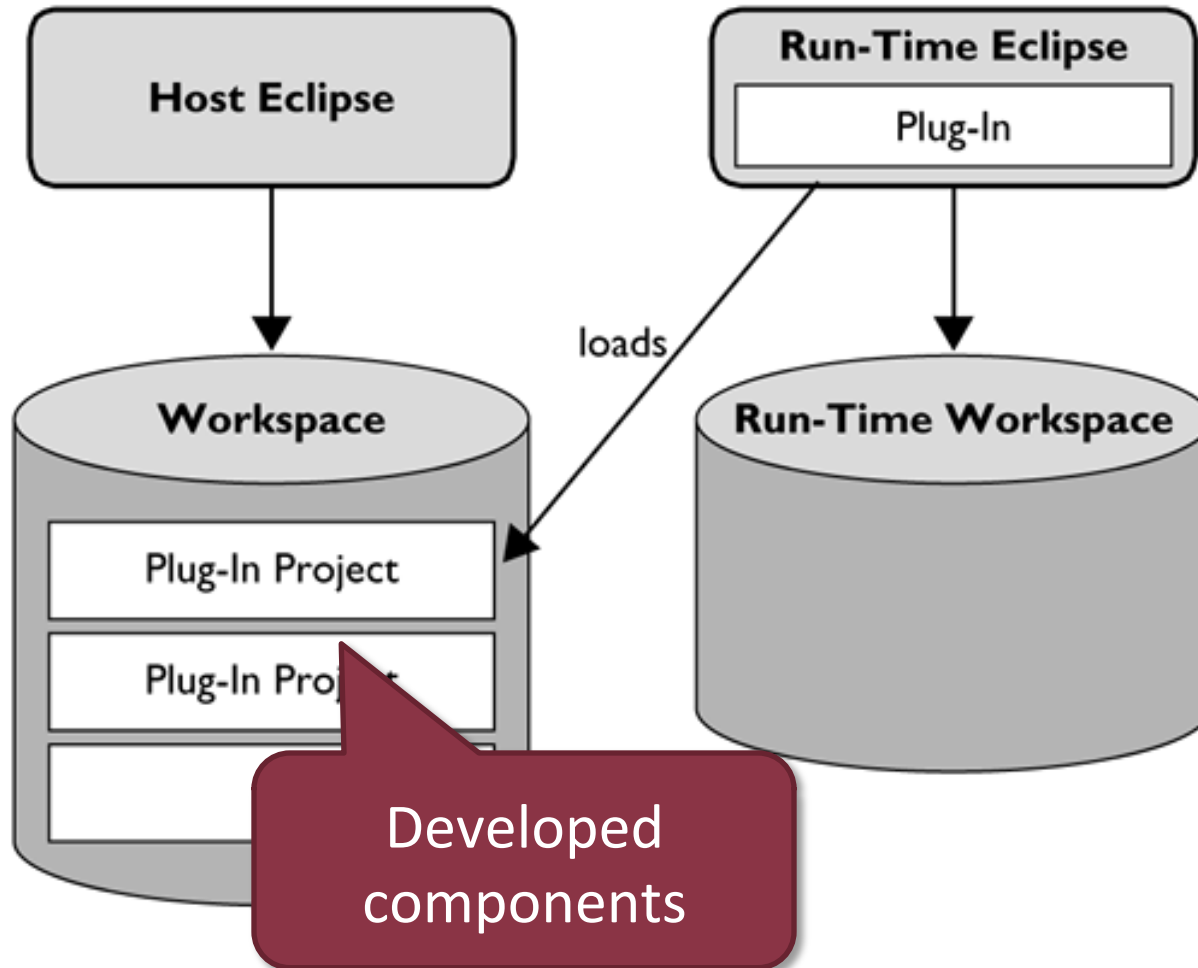

Execution

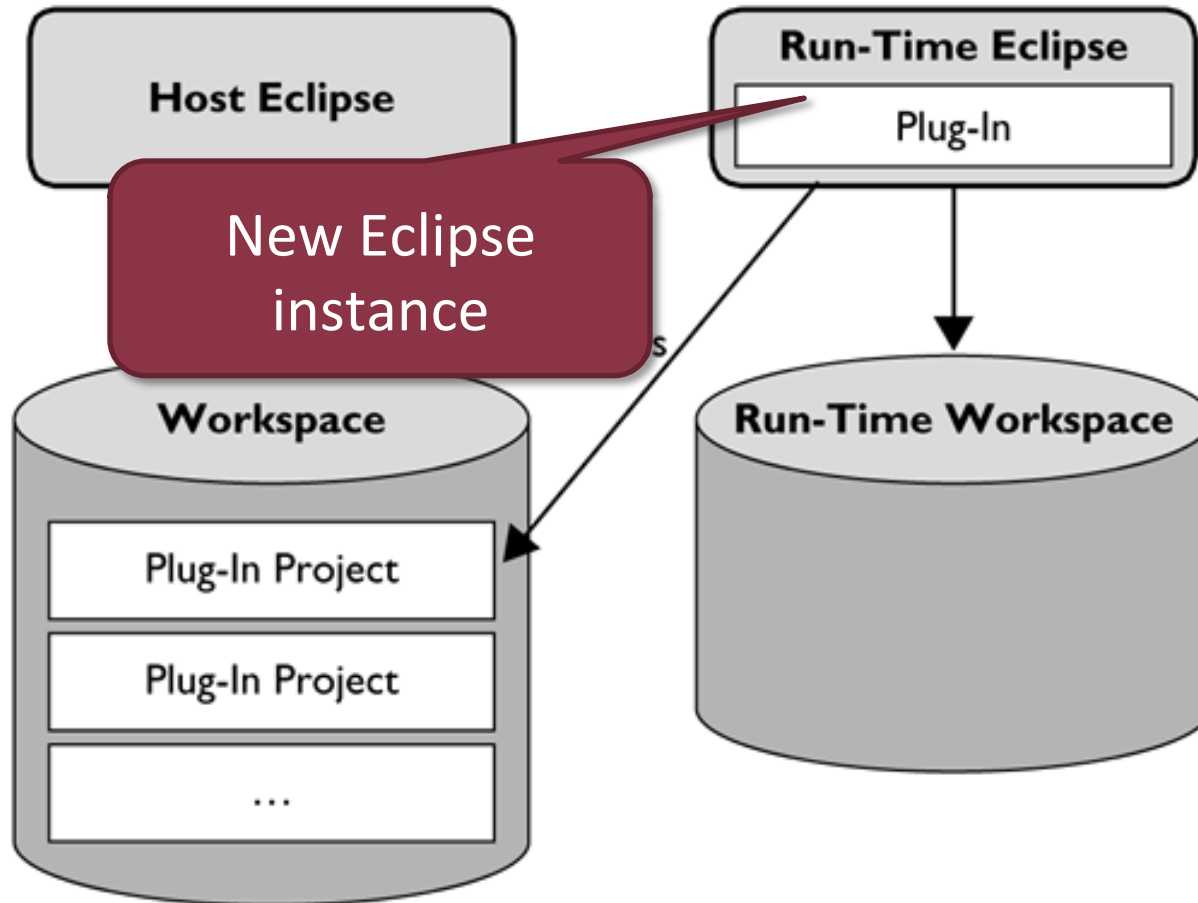

Execution

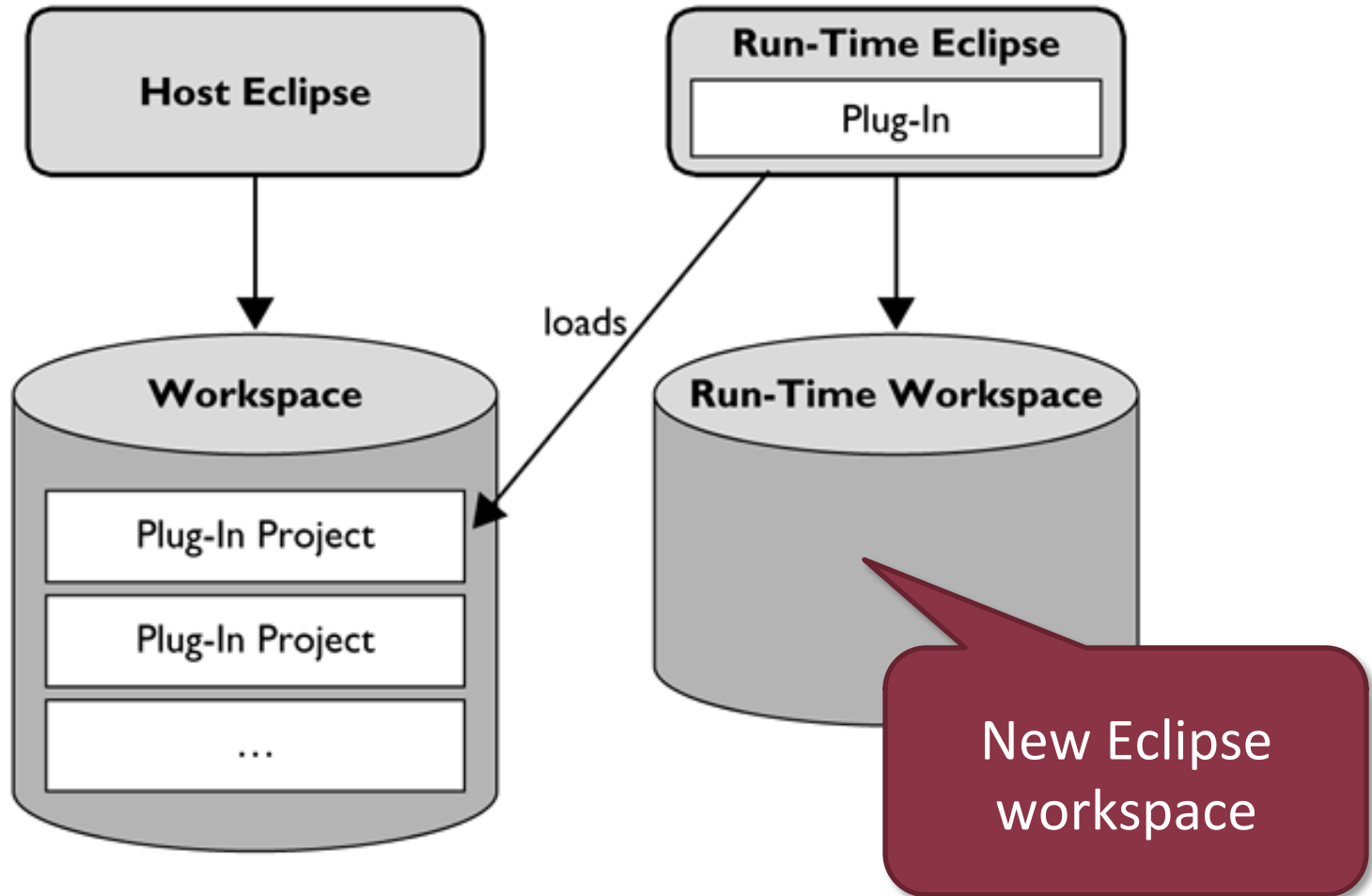

Common Extensions

Eclipse UI (3.x)

Workbench

- Workbench
 - A Window of an Eclipse-based application
 - Fixed set of elements supported
 - Configurable

Workbench structure

Workbench window

The screenshot displays the Eclipse IDE interface. The Package Explorer on the left shows a project structure with the following components:

- hu.optxware.eclipsecourse
 - hu.optxware.eclipsecourse
 - JRE System Library [Java]
 - Plug-in Dependencies
 - src
 - hu.optxware.eclipsecourse
 - Activator.java
 - Application.java
 - ApplicationActionBarAdvisor.java
 - ApplicationWorkbenchAdvisor.java
 - ApplicationWorkbenchWindowAdvisor.java
 - BookListView.java
 - BookListViewContentProvider.java
 - Perspective.java
 - ServiceInterface.java
 - ServiceManager.java
 - hu.optxware.eclipsecourse.rcpdemo.gui.comr
 - ExitHandler.java
 - icons
 - META-INF
 - OSGI-INF
 - build.properties
 - plugin.xml
 - splash.bmp
 - hu.optxware.eclipsecourse.rcpdemo.model.simple

The main editor window shows the code for `ServiceInterface.java`:

```
ServiceInterface {  
    serviceCreated();  
    serviceRemoved();  
}
```

The Outline view on the right shows the class structure:

- hu.optxware.eclipsecourse
 - ServiceInterface
 - serviceCreated() : void
 - serviceRemoved() : void

The bottom status bar shows the following information:

- Writable
- Smart Insert
- 1 : 1

Workbench structure

The screenshot displays the Eclipse IDE interface. At the top, a blue box highlights the main toolbar, which contains various icons for file operations, editing, and development. A red callout bubble with the text "Main toolbar" points to this area. The main workspace is divided into several panes: the Package Explorer on the left shows a project hierarchy with "ServiceInterface.java" selected; the central editor shows the code for "ServiceInterface" with methods "serviceCreated()" and "serviceRemoved()"; the Outline view on the right shows the project structure; and the Problems view at the bottom shows "0 items". The status bar at the bottom indicates "Writable", "Smart Insert", and "1 : 1".

Main toolbar

```
package hu.optxware.eclipsecourse.rcpdemo.gui;

public interface ServiceInterface {
    void serviceCreated();
    void serviceRemoved();
}
```

Description	Resource	Path	Location	Type

Workbench Site

- Contains *Parts*
 - Editors (editor part)
 - Views (view part)
- Views are arranged according to selected *Perspective*

Perspectives

- A functional group of Views
 - Layout description as well
 - Task-specific collection
- Examples
 - Java Development
 - Plug-in Development
 - Debug
 - Team Synchronizing

Perspective Implementation

- Perspective
 - Extension point: org.eclipse.ui.perspectives
 - Interface: IPerspectiveFactory
- Layouting support for views
 - Place all views related to editor area
- Further options
 - Perspective extensions can be used to extend an already defined view

Structure of Views

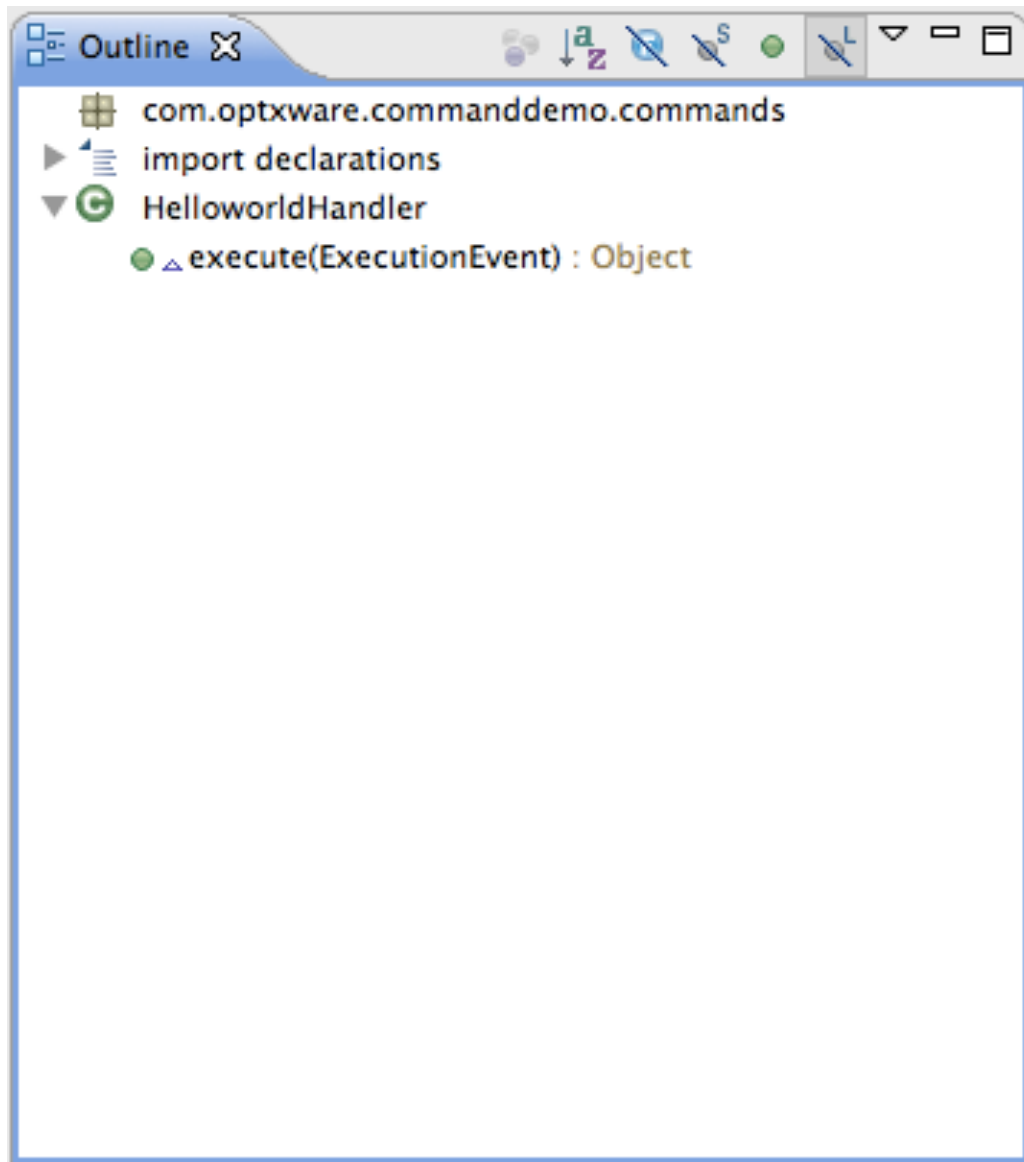

Structure of Views

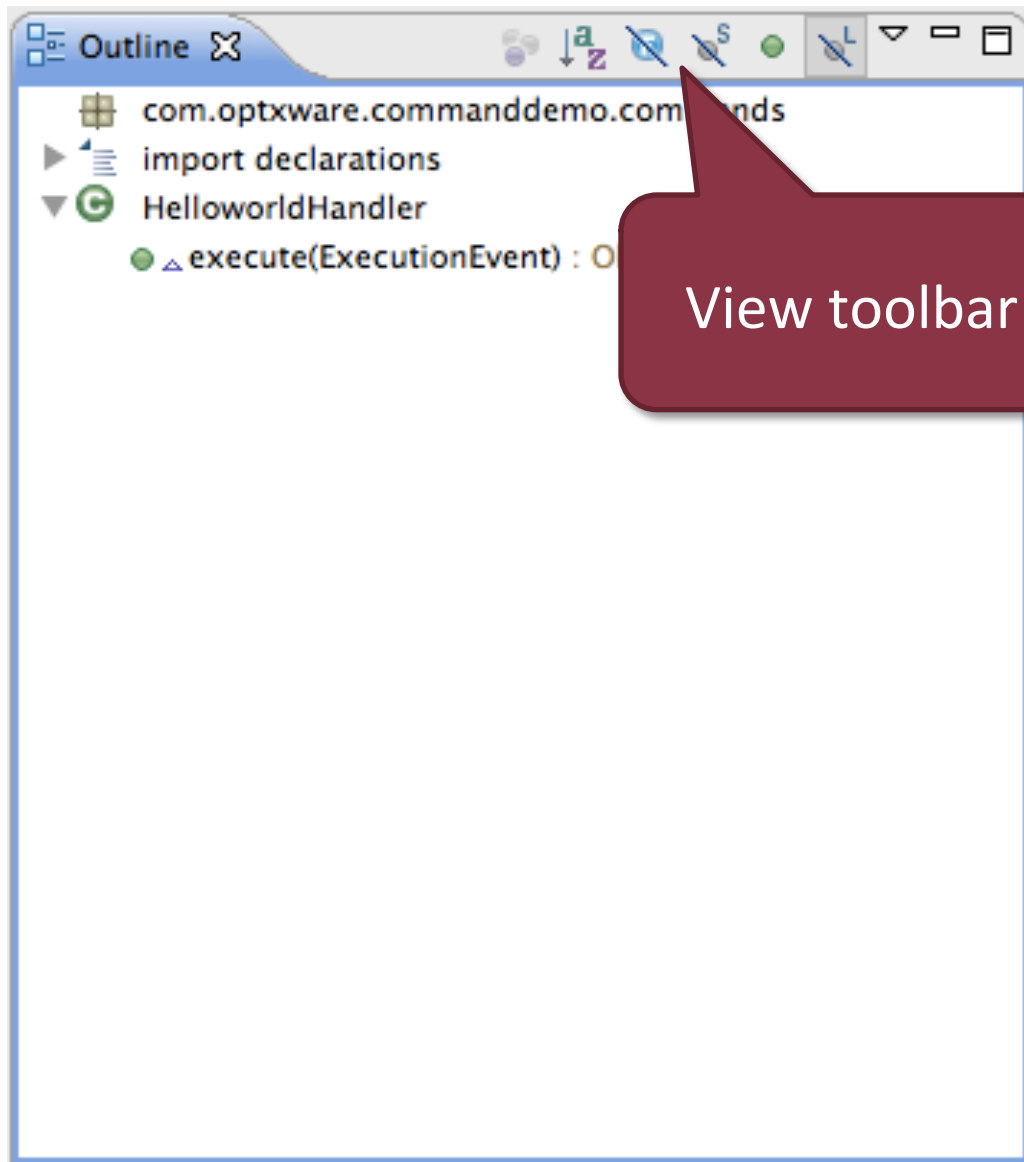

Structure of Views

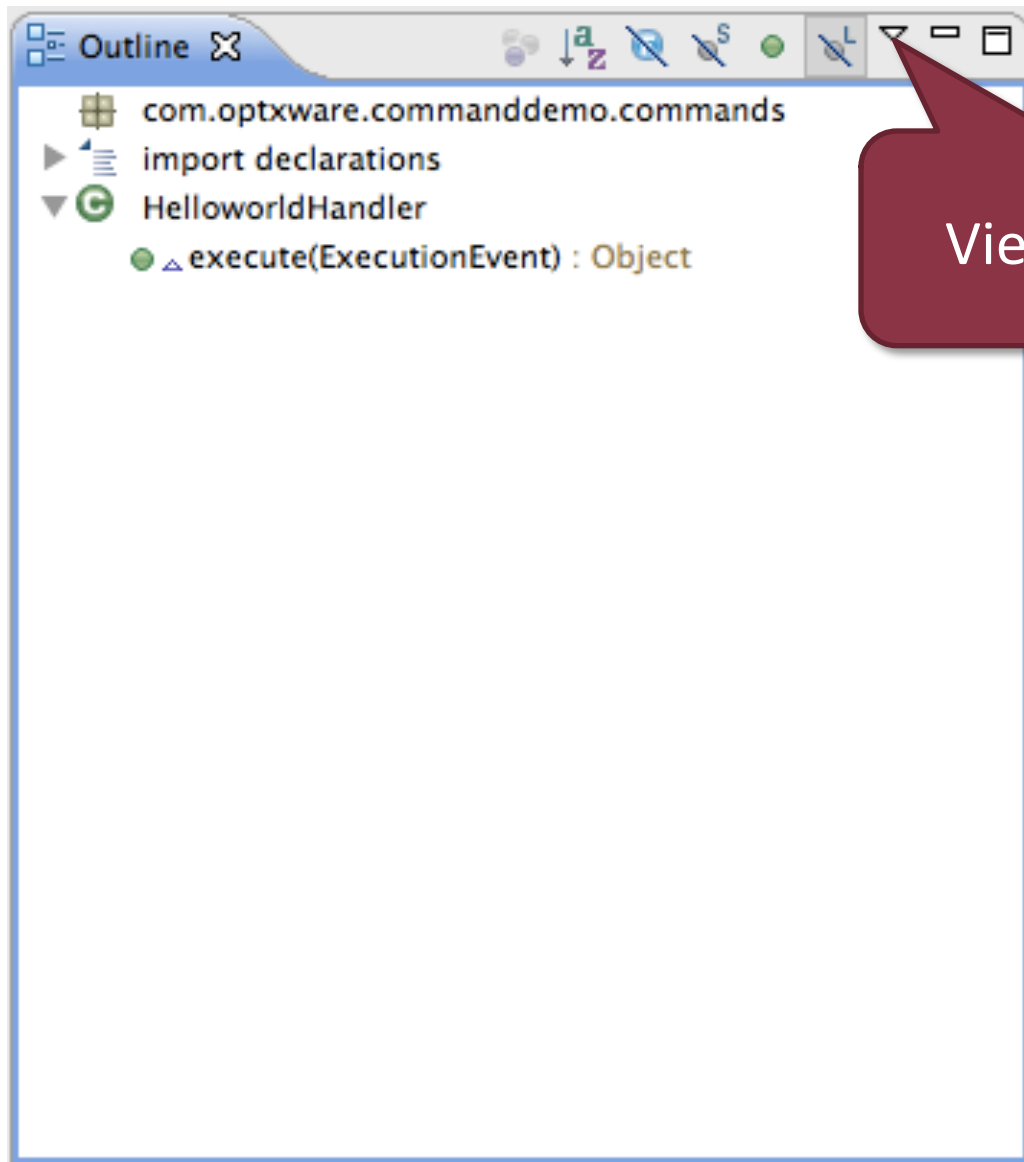

View menu

Structure of Views

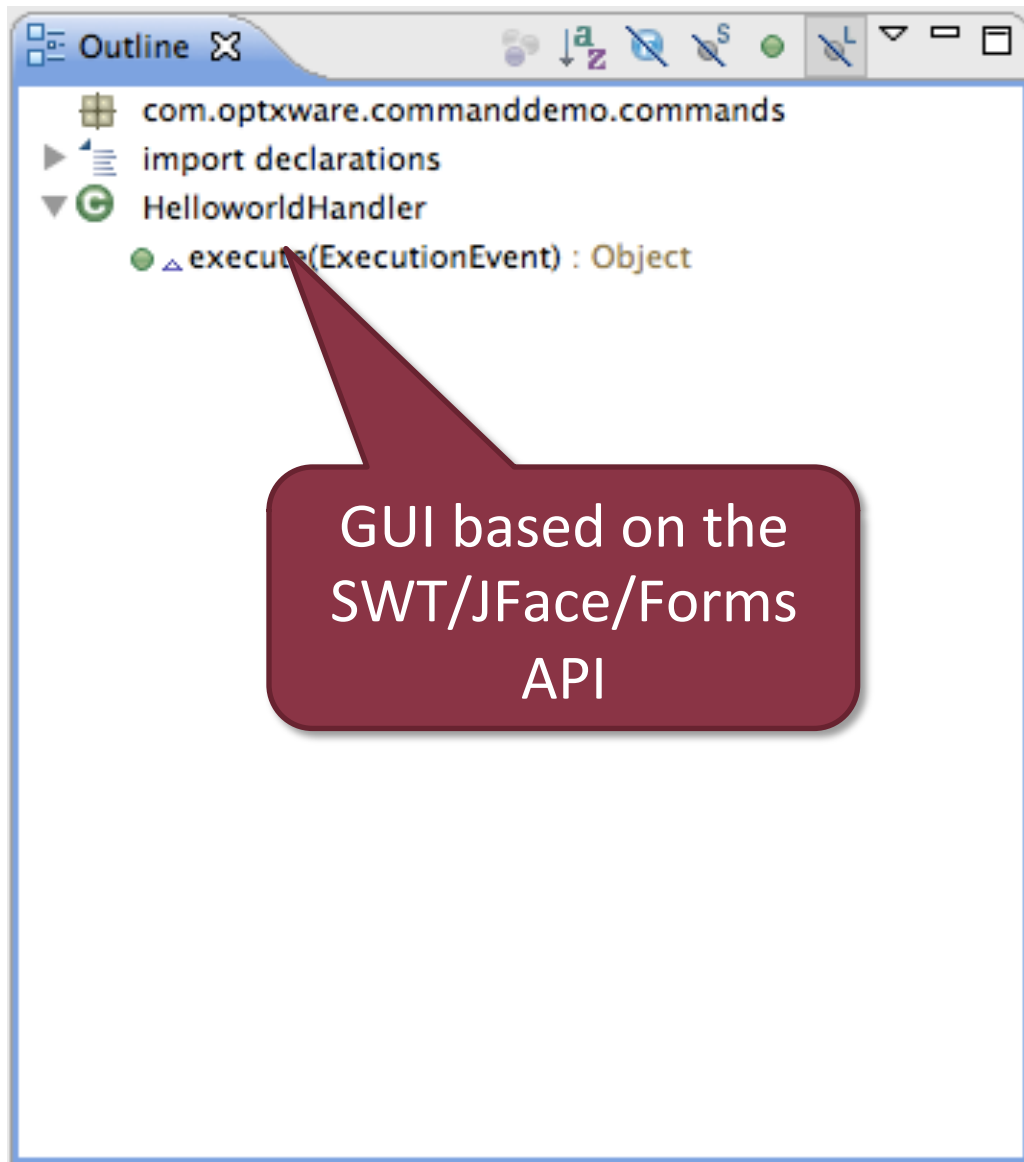

Views

- Helper elements for editors
 - Goal to display additional information
- May be global
 - Project Explorer
 - Error Log
- May depend on current editor/selection
 - Properties view – current selections properties
 - Outline view – quick overview of current editor contents

Implementing Views

- View
 - Extension point: org.eclipse.ui.views
 - Interface: IViewPart
- Goals
 - Presenting information
 - Editing information
 - Handling context changes
 - E.g. selection has changed

Example View Implementation

```
public class View extends ViewPart {  
  
    public static final String ID =  
        "hu.bme.mit.app.view";  
  
    public void  
createPartControl(Composite parent)  
{  
    //View controls initialization  
}  
  
    public void setFocus() {  
        viewer.getControl().setFocus();  
    }  
}
```

Workbench structure

Editors (0..N) for open files

```
package hu.optxware.eclipsecourse.rcpdemo.gui;

public interface ServiceInterface {

    public void serviceCreated();

    public void serviceRemoved();

}
```

hu.optxware.eclipsecourse.rcpdemo.gui.com

- ApplicationWorkbenchAdvisor.java
- ApplicationWorkbenchWindowAdvisor.java
- BookListView.java
- BookListViewContentProvider.java
- Perspective.java
- ServiceInterface.java
- ServiceManager.java
- ExitHandler.java

0 items

Description	Resource	Path	Location	Type

Editor

- For editing purposes
 - Typically file editor
 - One of more files
 - But can be something else
 - contents of a database
 - compare editor
- Technologies
 - Textual (e.g. Java editor)
 - Form-based (e.g. plug-in manifest editor)
 - Graphical (e.g. UML editor)
 - Multi-page (each page may be different)

Editor registration

- Editor
 - Extension point: org.eclipse.ui.editor
 - Interface: IEditorPart
- Minimal functionality
 - Displaying editor
 - State display
 - Loading/saving data
- Building (compiling) is not the job of an editor!

Editor implementation

- `createPartControls(Composite parent)`
 - Defines the GUI elements of the editor
 - Can be any possible form
 - E.g. textual editors use a single multiline textedit component
- `init(IEditorSite site, IEditorInput input)`
 - Initializing editor
 - Loading data model
 - Presenting data model on widgets
 - Each editor must implement this

Editors – Managing Data Models

- IEditorInput: Data model handle
 - Minimal information that is required to load all contents
 - Must not contain the entire model
 - The handle remain open even after the editor closes
- Handle types
 - FileEditorInput
 - Describes a file in the workspace
 - CompareEditorInput
 - Compares and edits multiple version of file(s)
 - MultiEditorInput
 - For multi-page editors
 - Extensible with custom handle

Editors – Editor state

- `isDirty()`
 - Signals whether the contents have changed
 - If true, the *Save* command is enabled
- After editing the editor **must** send notification
 - `firePropertyChange(PROP_DIRTY);`
 - Pull notification: new value is not pushed
 - `isDirty()` will be called in the future

Editors – Saving the Data Model

- `isSaveAsEnabled()`
 - Describes whether a copy can be made to a new file
- `doSave(IProgressMonitor monitor)`
 - Handler for the system-wide *Save* command
 - Saving is to be coded manually
 - It is possible to show save progress
- `doSaveAs()`
 - Handler for the system-wide *Save as* command
 - Save dialog is handled manually
 - Saving is coded manually
 - Monitor is missing!

Editors – Additional concepts

- Textual editor
 - AbstractTextEditor descendant
 - Xtext, EMFText or IMP projects
 - Higher level techniques
- Graphical editor
 - Graphical Editing Framework (GEF) project
 - Graphical Modeling Framework (GMF) project
- Multipage editors
 - MultiPageEditor descendant
 - Every page can be of a selected type

Command Framework

Actions vs Commands

- Menus, Pop-up menus and Toolbar items
 - Two approaches
 - JFace Actions
 - Older approach
 - Do not use in new projects (unless really necessary)
 - Just a very brief overview here
 - Command Framework (Eclipse 3.3 óta)
 - Eclipse 4.x API is based on this model

Actions

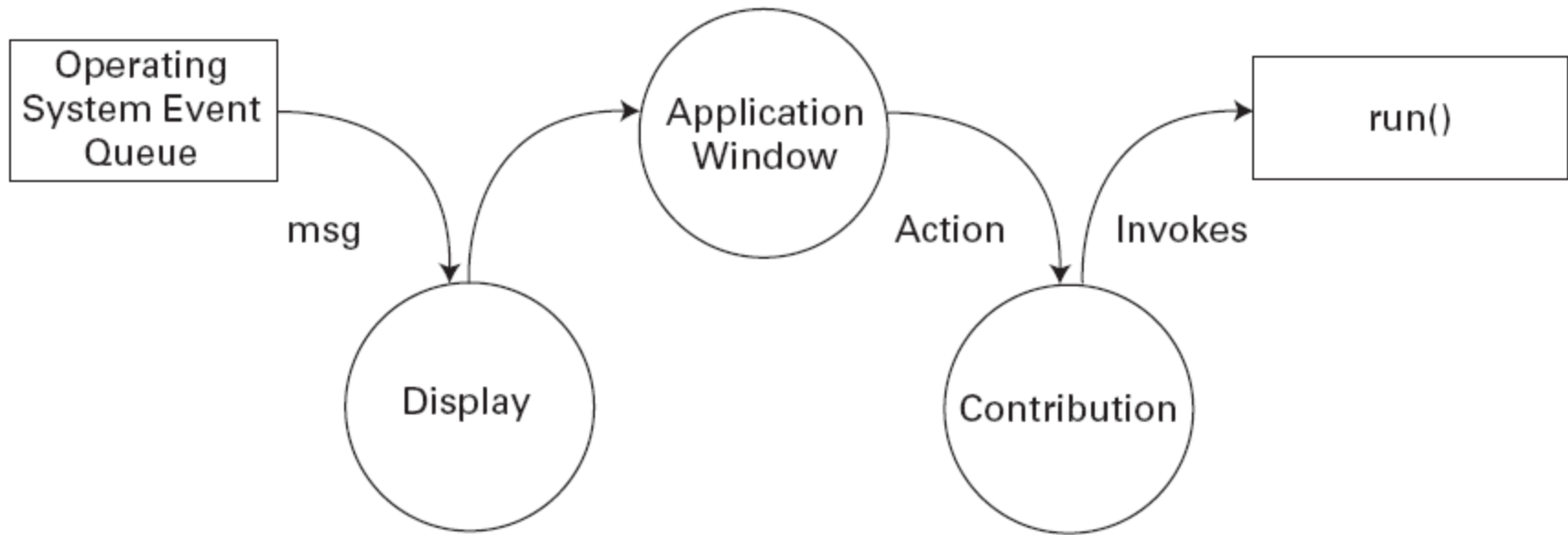

■ Actions

- Created by user interface events
- For each action contributions are registered
 - The system chooses and executes the current contribution

Action registration

- Multiple extension points (depending of goal)
 - org.eclipse.ui.editorActions
 - For editor menus
 - Interfész: IEditorActionDelegate
 - org.eclipse.ui.viewActions
 - For view menus
 - Interfész: IViewActionDelegate
 - org.eclipse.ui.popupMenus
 - For pop-up menus
 - Interfész: IEditorActionDelegate v. IViewActionDelegate v. IObjectActionDelegate

Action implementations

- org.eclipse.jface.action.Action descendants
 - run()
 - Main execution method
 - Attributes
 - Presentation: text, toolTipText, image, etc.
 - Behavior: enabled, checked

Use cases for item re-use

- Re-use supported
 - Existing command
 - Menu item/icon/binding
 - Command handler
 - What to re-use
 - Clipboard operations on view
 - Clipboard operation on editor
 - Textual
 - Graphical

Evaluation

- Multiple
 - Extension points
 - Java interfaces
- Presentation and behavior is not separated
- Problem
 - re-using Actions is problematic
 - XML duplication for registration
 - multiple Action interfaces are needed

Command Framework

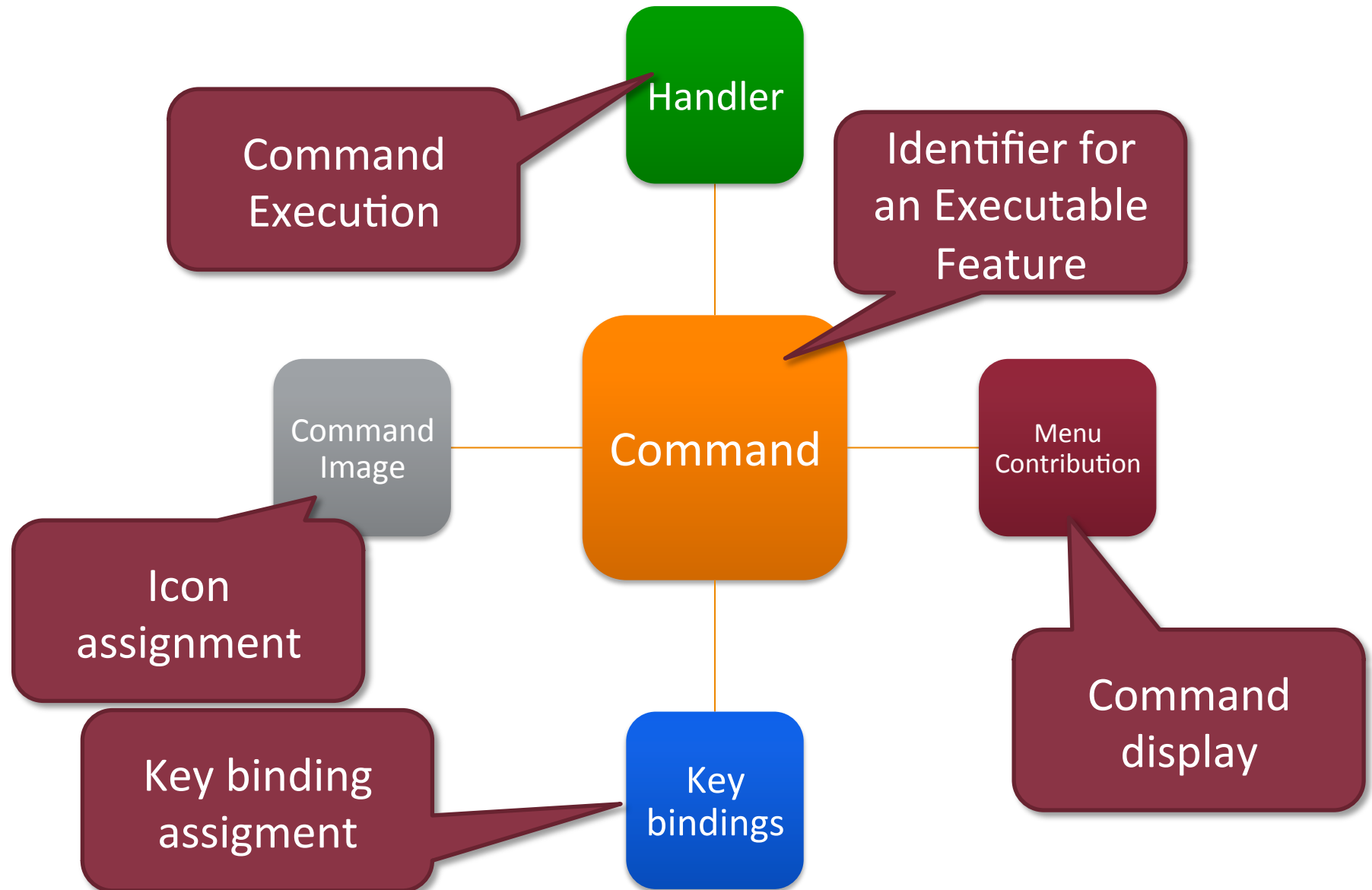

Command

- Extension point: `org.eclipse.ui.commands`
- Mandatory attributes
 - Identifier
 - Name (for user interface)
- Optional attributes
 - Category
 - Default handler (not recommended to set)

Command example

```
<extension point="org.eclipse.ui.commands">  
  <command  
    description="Shows a Hello, world message."  
    id="hu.mit.bme.commanddemo.helloworld"  
    name="Display hello world">  
  </command>  
</extension>
```

Handler

- Extension point: `org.eclipse.ui.handlers`
- Mandatory parameters
 - Command identifier
 - `IHandler` or `AbstractHandler` descendant Java class
- Executable code
 - `execute(ExecutionEvent event)` method of Handler class
 - `ExecutionEvent`
 - Context information for execution
 - Use `HandlerUtil` for evaluation

Selecting the current Handler

- Multiple handlers for a single command
- Choice required
 - activeWhen: activation condition (Core Expression - later)
 - enabledWhen: enablement condition (Core Expression)
- Choice algorithm:
 - All handlers with true activeWhen
 - Choose most specific condition (later)
 - If more than one handler remain, consider command disabled!

Core Expression

- Context condition setting in extensions
 - For evaluation plug-in code needs not to be loaded
- Possible conditions
 - Class checking
 - Count conditions
 - Comparisons
 - Logical operations (and, or, ...)
 - ...

Conditions on

- Active Context
- Active Action Sets
- Active Shell
- Active Workbench Window
- Active editor
- Active part
- Current selection

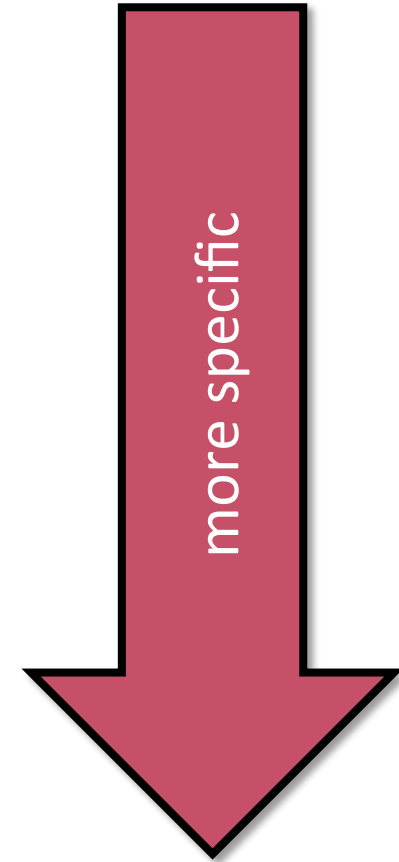

Example: Core Expression

- The current selection contains an IFile

```
<with variable = "selection">  
  <iterate operator ="or">  
    <instanceof  
      value =  
      "org.eclipse.core.resources.IFile">  
    </instanceof>  
  </iterate>  
</with>
```

Example: Core Expression

- The Java editor of JDT is active

```
<with variable = "activeEditorId">  
  <equals value =  
    "org.eclipse.jdt.ui.CompilationUnitEditor">  
  </equals>  
</with>
```

Example: Handler registration

- Handler active when Java editor is active

```
<extension point="org.eclipse.ui.handlers">  
  <handler  
    class=  
      "hu.bme.mit.commanddemo.handlers.helloworld"  
    commandId="hu.bme.mit.commanddemo.helloworld">  
    <activeWhen><with variable = "activeEditorId">  
      <equals  
  
value="org.eclipse.jdt.ui.CompilationUnitEditor">  
        </equals>  
      </with></activeWhen>  
    </handler>  
  </extension>
```

Contribution

- Extension point: org.eclipse.ui.menus
- Describes the place of contribution
 - URL: "[Scheme]:[ID]?[Query]"
 - Scheme
 - Contribution type
 - Supported values: menu, popup, toolbar
 - ID
 - identifying the view/editor/toolbar
 - Query
 - more precise positioning inside the menu/toolbar
 - e.g. after the *Run* contribution

Contribution

■ Attributes

○ Mandatory

- Command ID

○ Optional

- Contribution ID (for query part of URL)
- Label (if not set, the command name is used)
- Icon (use CommandImages instead)

○ Visibility conditions with Core Expression

- visibleWhen child

Example: Contribution

- Toolbar icon for the main toolbar (technically a toolbar of toolbars)

```
<extension point="org.eclipse.ui.menus">
  <menuContribution      locationURI =
    "toolbar:org.eclipse.ui.main.toolbar">
    <toolbar id="hu.bme.mit.commanddemo.toolbar1">
      <command commandId=
        "hu.bme.mit.commanddemo.helloworld"
        id="hu.bme.mit.commanddemo.helloworldInToolbar"
        label="Hello, world!"
        style="push"
        tooltip="Displays a hello, world
dialog.">
      </command>
    </toolbar>
  </menuContribution>
</extension>
```

Example: Contribution

- Toolbar icon for the main toolbar (part of a set of toolbars)

```
<extension point="org.eclipse.ui.commands" >
  <menuContribution
    id="hu.bme.mit.commanddemo.toolbar"
    "toolbar:org.eclipse.ui.main.toolbar">
    <toolbar id="hu.bme.mit.commanddemo.toolbar1">
      <command commandId=
        "hu.bme.mit.commanddemo.helloworld"
        id="hu.bme.mit.commanddemo.helloworldInToolbar"
        label="Hello, world!"
        style="push"
        tooltip="Displays a hello, world
        dialog.">
      </command>
    </toolbar>
  </menuContribution>
</extension>
```

URL

Example: Contribution

- Toolbar icon for the main toolbar (technically a toolbar of toolbars)

```
<extension point="org.eclipse.ui.menus">
  <menuContribution      locationURI =
    "toolbar:org.eclipse.ui.main.toolbar">
    <toolbar id="hu.bme.mit.commanddemo.toolbar1">
      <command commandId=
        "hu.bme.mit.commanddemo.hello"
        id="hu.bme.mit.commanddemo.hello"
        label="Hello, world"
        style="push"
        tooltip="Displays a hello, world
        dialog.">
      </command>
    </toolbar>
  </menuContribution>
</extension>
```

New toolbar
(needed on main
toolbar)

Example: Contribution

- Toolbar icon for the main toolbar (technically a toolbar of toolbars)

```
<extension point="org.eclipse.ui.menus">
  <menuContribution locationURI =
    "toolbarContribution.se.ui.main.toolbar">
    <toolbar id="hu.bme.mit.commanddemo.toolbar1">
      <command commandId=
        "hu.bme.mit.commanddemo.helloworld"
        id="hu.bme.mit.commanddemo.helloworldInToolbar"
        label="Hello, world!"
        style="push"
        tooltip="Displays a hello, world
dialog.">
      </command>
    </toolbar>
  </menuContribution>
</extension>
```

Command ID

Command Icons

- Extension points: `org.eclipse.ui.commandImages`
- Mandatory attributes
 - Command ID
 - Icon
- Goal:
 - Assign icons to command
- Contribution should not contain the default icon
 - Multiple contributions of the same command!
 - Contribution might reside in a different plug-in

Example: Command Icons

```
<image
```

```
  commandId="hu.bme.mit.commanddemo.helloworld"  
  icon="icons/sample.gif">
```

```
</image>
```

Key bindings

- Extension point: `org.eclipse.ui.bindings`
- Goal: assigning key bindings to commands
- Mandatory attributes:
 - Sequence: the key sequence
 - Emacs style longer sequences also supported
 - SchemeID: key binding scheme selection
 - ContextID: selecting where the binding is active
 - CommandID
- Optional attributes:
 - Platform: for platform-specific bindings
 - Locale: for language-specific bindings

Example: binding

```
<key
sequence =
  "M2+F5"
commandId =
  "hu.bme.mit.rcpdemo.list"
schemeId =
  "org.eclipse.ui.defaultAcceleratorCo
nfiguration"
contextId =
  "org.eclipse.ui.contexts.dialog" />
```

M2: modifier key;
platform-dependent
value

Further Sources

- Eclipse Commands Tutorial

- <http://www.vogella.de/articles/EclipseCommands/article.html>

- Eclipse Platform Architecture

- <http://help.eclipse.org/indigo/topic/org.eclipse.platform.doc.isv/guide/arch.htm>